

Engineered
for the **real world**

AU Solutions
for Final Distribution
Protection | Control | Monitoring







Real world technology created by listening to you



L&T Electrical & Automation is India's leading manufacturer of low-voltage and medium-voltage switchgear for industries, buildings, homes and agriculture segments.

Since the start of our journey, we have listened, observed and experienced our customers' needs. AU Solutions is a range of protection, control and monitoring devices born from the learning gained.

From protection against overload and earth leakage to lightning and switching surges, this range offers more than expected – meeting your needs of today and tomorrow.



Translating technology into **real** benefits



AU Solutions for final distribution offer a unique blend of safety, convenience and performance. Each product in the AU Solutions range is designed to provide lasting benefits.

Lowest Watt Loss Saves money and natural resources

MCBs from AU Solutions offer the lowest watt loss in the industry. On an average, the watt loss values are almost 55% lower than those prescribed by IEC.

Lower watt loss means lower power consumption, which directly translates into monetary savings. Beyond tangible benefits, lower power requirement also hints at lower consumption of natural resources used for producing energy. In a nutshell, these MCBs are a small, yet significant step towards sustainability.

Power Loss Per Pole (W)

Current Ratings (A)	As Per IS/IEC 60898	For AU Range of MCBs	% lower
0.5	3	1.9	38%
1	3	2	33%
1.6	3	2.1	30%
2	3	2.1	30%
3	3	2.1	30%
4	3	2.1	30%
5	3	2.1	30%
6	3	1.1	63%
10	3	1.2	60%
16	3.5	1.8	50%
20	4.5	1.9	58%
25	4.5	2.1	54%
32	6	2.4	60%
40	7.5	3.1	59%
50	9	4.1	54%
63	13	4.3	67%
80	15	3.9	74%
100	15	6.2	59%
125	20	9.2	54%

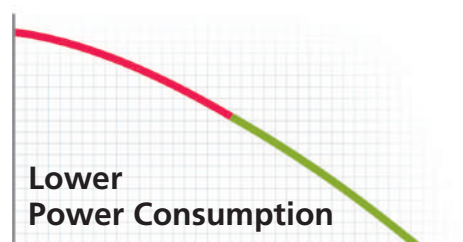

Greater Savings



Towards Sustainability



For reducing extra gases



For driving extra miles



For electrifying extra houses



Short-circuit Fault Indicator

Easy diagnosis, saves downtime

With the unique short-circuit fault indication feature, one can conclude if the MCB has tripped due to a short-circuit fault.

It helps in reducing downtime as the faulty phase and cause of MCB tripping are easily detected.

If the MCB has tripped on 'overload', non-critical loads can be switched OFF before switching the MCB ON again.

In the case of a short-circuit fault, the location and cause of the short-circuit should be identified and the necessary corrective action should be taken.



Quick Connect

Saves time

Quick Connect MCBs offer spring-loaded terminals as against conventional termination.

Both flexible and rigid wires can be terminated by sliding them along the termination groove; no tool is required for terminating the rigid wire.

Quick Connect MCBs can be terminated in a mere 1-2 seconds* as against 10-15 seconds required for standard MCBs.

With Quick Connect MCBs, the installer can achieve a reduction in installation time by around 30%, increasing overall productivity.

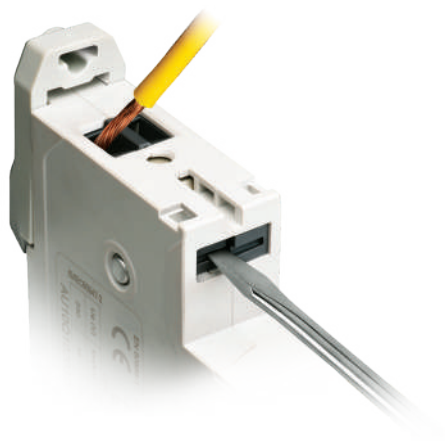

Communication Capability

For smart systems

With the communication capability of AU Solutions, one can monitor and control various devices remotely.

The complete communication system can be deployed for effective energy management.



RoHS Compliance

Environment-friendly

RoHS compliant AU Solutions do not use any substances which are hazardous to the environment.



*Quick Connect section with rigid wire

A comprehensive range for **real world** applications



Real-world applications are varied and spread across segments and geographies.

We, at L&T Electrical & Automation (E&A), are aware that final distribution products are needed for a diverse range of applications – from residential buildings to industrial installations.

Presenting the range that meets all your needs – AU Solutions for Final Distribution!

**Manufactured at E&A's state-of-the art
facility at Ahmednagar, Maharashtra**





Protection

- MCBs
- RCCBs
- RCBOs
- SPDs

Monitoring

- Accessories
- Energy Meters
- Indicating Lights

Control

- Isolators
- Modular Contactors
- Changeover Switches
- Time Switches
- Automatic Changeover with Current Limiter

AU-COM



**ELECRAMA 2014
BEST PRODUCT**

in the category of
'Product Developed by
an Indian Exhibitor'.



CONTENTS

A		<table border="0"> <tr> <td>PROTECTION DEVICES</td> <td style="text-align: right;">7</td> </tr> <tr> <td>MCBs</td> <td style="text-align: right;">8</td> </tr> <tr> <td>RCCBs</td> <td style="text-align: right;">15</td> </tr> <tr> <td>RCBOs</td> <td style="text-align: right;">19</td> </tr> <tr> <td>SPDs</td> <td style="text-align: right;">24</td> </tr> </table>	PROTECTION DEVICES	7	MCBs	8	RCCBs	15	RCBOs	19	SPDs	24		
PROTECTION DEVICES	7													
MCBs	8													
RCCBs	15													
RCBOs	19													
SPDs	24													
B		<table border="0"> <tr> <td>MONITORING DEVICES</td> <td style="text-align: right;">28</td> </tr> <tr> <td>Accessories</td> <td style="text-align: right;">29</td> </tr> <tr> <td>Energy Meters</td> <td style="text-align: right;">35</td> </tr> <tr> <td>Indicating lights</td> <td style="text-align: right;">38</td> </tr> </table>	MONITORING DEVICES	28	Accessories	29	Energy Meters	35	Indicating lights	38				
MONITORING DEVICES	28													
Accessories	29													
Energy Meters	35													
Indicating lights	38													
C		<table border="0"> <tr> <td>CONTROL DEVICES</td> <td style="text-align: right;">40</td> </tr> <tr> <td>Isolators</td> <td style="text-align: right;">41</td> </tr> <tr> <td>Changeover Switches</td> <td style="text-align: right;">44</td> </tr> <tr> <td>Modular Contactors</td> <td style="text-align: right;">47</td> </tr> <tr> <td>Time Switches</td> <td style="text-align: right;">50</td> </tr> <tr> <td>ACCL</td> <td style="text-align: right;">53</td> </tr> </table>	CONTROL DEVICES	40	Isolators	41	Changeover Switches	44	Modular Contactors	47	Time Switches	50	ACCL	53
CONTROL DEVICES	40													
Isolators	41													
Changeover Switches	44													
Modular Contactors	47													
Time Switches	50													
ACCL	53													
D		<table border="0"> <tr> <td>AU-COM</td> <td style="text-align: right;">56</td> </tr> <tr> <td>Communication Solution</td> <td></td> </tr> </table>	AU-COM	56	Communication Solution									
AU-COM	56													
Communication Solution														
E		<table border="0"> <tr> <td>TECHNICAL REFERENCES</td> <td style="text-align: right;">60</td> </tr> </table>	TECHNICAL REFERENCES	60										
TECHNICAL REFERENCES	60													



PROTECTION DEVICES

Protection devices in the AU Solutions range protect lives and installations from overload, short-circuit, earth leakage, lightning and switching surges.

MCBs

- 0.5A-125A
- B, C, D Curves
- SP, DP, TP, FP, SPN, TPN

RCCBs

- 16A-100A
- 10mA-500mA
- DP, FP
- Type AC, Adi

RCBOs

- 6A-100A
- 10mA-300mA
- DP, FP
- Type AC, Adi

SPDs

- Type 1+2, Type 2
- 1P+N, 3P+N

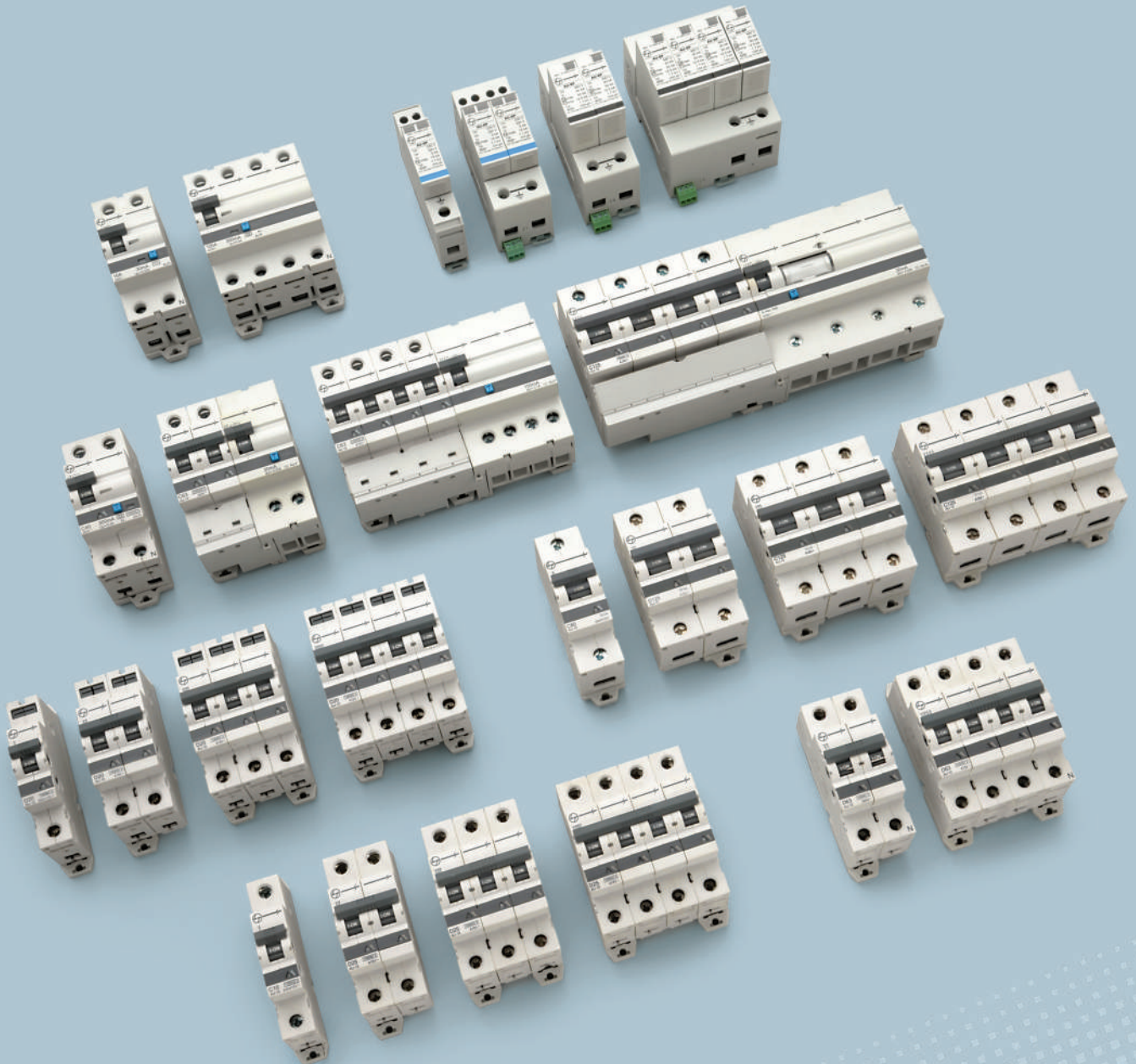



MCBs - Protection with savings

Apart from providing protection against overload and short-circuit faults, the AU range of MCBs is designed to offer the **lowest watt loss** in the industry. This conserves power and helps you save much more than money.

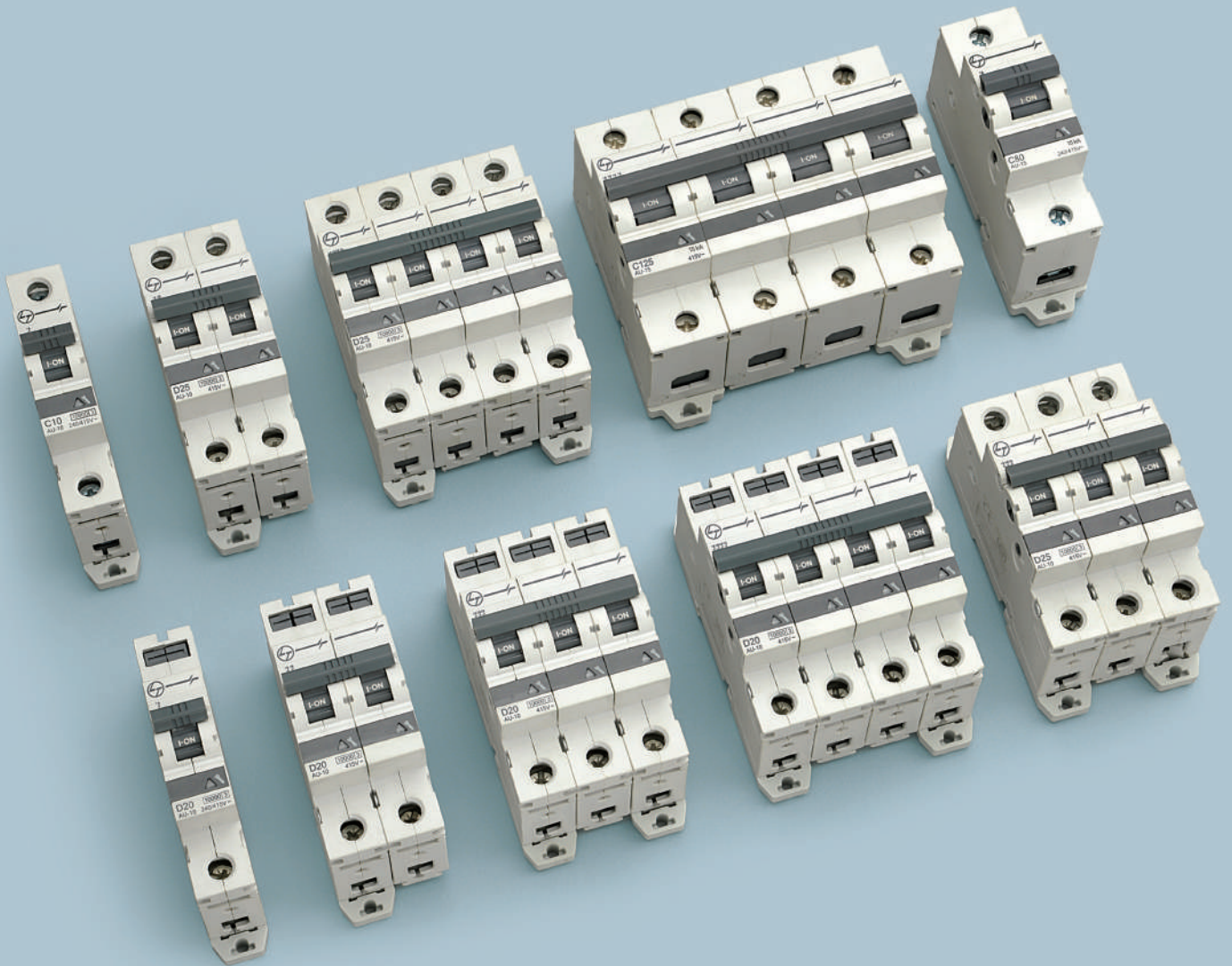

AU-10, AU-15 Range of MCBs



Engineered for higher safety and installation convenience

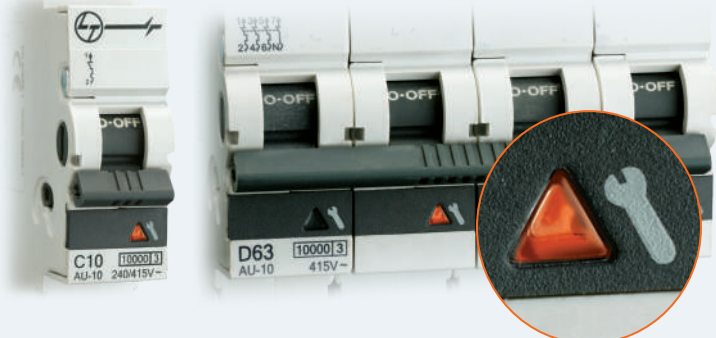

Unique Benefit

Short-circuit Fault Indication

- Indicates that the MCB has tripped on a short-circuit fault
- Clear indication by amber coloured flag
- Easy detection of occurrence of a short-circuit fault
- Faulty phase detection in multi-pole MCBs
- Clear differentiation between overload and short-circuit fault

Introducing in India



Terminate the cable with just a click

- **'Quick Connect' Design**
 - Both, flexible and rigid wires can be terminated by sliding them along the termination groove; no tool required for terminating the rigid wire.
 - Reduces installation time

Lowest Watt Loss

- MCBs from AU Solutions offer the lowest watt loss in the industry.
- On an average, the watt loss values are almost 55% lower than those prescribed by IEC, and are the lowest among its kind of products.

Ensures Total Safety

- **True Position Indication**
 - Knob indicates actual position of the contacts inside



Ensures Safe Installation

- **Safety Shutter**
 - Avoids incorrect cable insertion



Prevents Unauthorized Access

- **Provision for PadLock**
 - Can be used either in ON or OFF position

Line-Load Reversibility

- Either side can be used to terminate supply or load

MCB Removability with Busbar in place

- A uniquely designed DIN clip, allows easy removal of the DIN mounted MCB while the connection busbar is in place with adjoining devices

Flexibility in Termination

- Bi-connect terminals offer busbar and cable termination on both incoming and outgoing sides

Quick Make-Quick Break, Trip-Free Mechanism

- This feature ensures reliable and safe product functioning



Range Highlights

- Conforms to IS/IEC 60898-1, EN 60898-1, IEC 60898-1 EN 60947-2, IEC 60947-2
- Wide Range of Current Ratings – 0.5A to 125A
- Short-circuit Breaking Capacity
 - 10kA (IEC 60898-1, EN 60898-1)
 - 15kA (IEC 60947-2, EN 60947-2)
- B, C & D Characteristics
- Available in SP, DP, TP, FP, SPN and TPN
- Suitable for DC Application
- Suitable for Isolation
- Protection Degree - IP 20
- Availability of wide Range of Site Mountable Accessories
- Energy limiting class – 3

Product Specifications

ELECTRICAL	
Tripping Characteristics	B Curve: 6A to 63A C Curve: 0.5A to 125A D Curve: 0.5A to 125A
Rated Operational Voltage	240/415V
Rated Insulation Voltage	500V
Rated Impulse Voltage	6kV
Rated Frequency	50Hz/60Hz
Rated Short-circuit Breaking Capacity, AC – 0.5A to 63A IEC 60898-1, EN 60898-1	10kA
Rated Short-circuit Breaking Capacity, DC – 0.5A to 125A IEC 60947-2	SP 130V : 10kA DP 250V : 10kA FP 500V : 10kA
Rated Short-Circuit Breaking Capacity, AC - 0.5 to 63A IEC 60947-2, EN 60947-2	15kA (0.5A to 40A) 10kA (50A & 63A)
Rated Short-circuit Breaking Capacity, AC – 80A to 125A IEC 60947-2, EN 60947-2	15kA
Electrical Life (Operating Cycles)	20,000 up to 32A 12,000 40A to 63A 5,000 80A to 125A

MECHANICAL	
Mechanical Life (Operating Cycles)	20,000
Vibration Resistance (in X, Y, Z direction)	3g in frequency 10-55Hz, 20 cycles
Shock Resistance (in X, Y, Z direction)	20g, 3 Shocks, with short duration of 10ms

INSTALLATION	
Terminal Capacity	35 mm ² (rigid) 25 mm ² (flexible) } up to 63A 70 mm ² (rigid) 50 mm ² (flexible) } 80A to 125A
Tightening Torque	4Nm
Mounting Position	Horizontal / Vertical / Flat

GENERAL	
Pollution Degree	3
Calibration Temperature	30°/ 40°/ 50°C
Operating Temperature	-25°C to +60°C

Decoding Product Cat. Nos: AU-10, AU-15

MCB	AU10	AU15																	
Standard / Quick Connect	S Standard	Q Quick Connect																	
Number of Poles	1 1 Pole	2 2 Pole	3 3 Pole	4 4 Pole	S SPN	T TPN													
Rating (A)	0E5 0.5A	001 1A	1E6 1.6A	002 2A	003 3A	004 4A	005 5A	006 6A	010 10A	016 16A	020 20A	025 25A							
Calibration	3	30 deg	4	40 deg	5	50 deg													
Characteristics	B	B Curve	C	C Curve	D	D Curve													

Example







MCB, 10kA	Standard Single Pole	5A	50 deg calibrated	D Curve
AU10	S1	005	5	D

Please contact nearest E&A Branch for products with 40°C and 50°C calibration temperature.









Product Range- Standard Version
 AU-10 | 10kA as per IS/IEC 60898-1



Description	Rating	Module	Cat. Nos.		
			B Curve	C Curve	D Curve
Single Pole  	0.5A	1	-	AU10 S10E53C	AU10 S10E53D
	1A	1	-	AU10 S10013C	AU10 S10013D
	1.6A	1	-	AU10 S11E63C	AU10 S11E63D
	2A	1	-	AU10 S10023C	AU10 S10023D
	3A	1	-	AU10 S10033C	AU10 S10033D
	4A	1	-	AU10 S10043C	AU10 S10043D
	5A	1	-	AU10 S10053C	AU10 S10053D
	6A	1	AU10 S10063B	AU10 S10063C	AU10 S10063D
	10A	1	AU10 S10103B	AU10 S10103C	AU10 S10103D
	16A	1	AU10 S10163B	AU10 S10163C	AU10 S10163D
	20A	1	AU10 S10203B	AU10 S10203C	AU10 S10203D
	25A	1	AU10 S10253B	AU10 S10253C	AU10 S10253D
	32A	1	AU10 S10323B	AU10 S10323C	AU10 S10323D
	40A	1	AU10 S10403B	AU10 S10403C	AU10 S10403D
	50A	1	AU10 S10503B	AU10 S10503C	AU10 S10503D
	63A	1	AU10 S10633B	AU10 S10633C	AU10 S10633D
Two Pole  	0.5A	2	-	AU10 S20E53C	AU10 S20E53D
	1A	2	-	AU10 S20013C	AU10 S20013D
	1.6A	2	-	AU10 S21E63C	AU10 S21E63D
	2A	2	-	AU10 S20023C	AU10 S20023D
	3A	2	-	AU10 S20033C	AU10 S20033D
	4A	2	-	AU10 S20043C	AU10 S20043D
	5A	2	-	AU10 S20053C	AU10 S20053D
	6A	2	AU10 S20063B	AU10 S20063C	AU10 S20063D
	10A	2	AU10 S20103B	AU10 S20103C	AU10 S20103D
	16A	2	AU10 S20163B	AU10 S20163C	AU10 S20163D
	20A	2	AU10 S20203B	AU10 S20203C	AU10 S20203D
	25A	2	AU10 S20253B	AU10 S20253C	AU10 S20253D
	32A	2	AU10 S20323B	AU10 S20323C	AU10 S20323D
	40A	2	AU10 S20403B	AU10 S20403C	AU10 S20403D
	50A	2	AU10 S20503B	AU10 S20503C	AU10 S20503D
	63A	2	AU10 S20633B	AU10 S20633C	AU10 S20633D
Three Pole  	0.5A	3	-	AU10 S30E53C	AU10 S30E53D
	1A	3	-	AU10 S30013C	AU10 S30013D
	1.6A	3	-	AU10 S31E63C	AU10 S31E63D
	2A	3	-	AU10 S30023C	AU10 S30023D
	3A	3	-	AU10 S30033C	AU10 S30033D
	4A	3	-	AU10 S30043C	AU10 S30043D
	5A	3	-	AU10 S30053C	AU10 S30053D
	6A	3	AU10 S30063B	AU10 S30063C	AU10 S30063D
	10A	3	AU10 S30103B	AU10 S30103C	AU10 S30103D
	16A	3	AU10 S30163B	AU10 S30163C	AU10 S30163D
	20A	3	AU10 S30203B	AU10 S30203C	AU10 S30203D
	25A	3	AU10 S30253B	AU10 S30253C	AU10 S30253D
	32A	3	AU10 S30323B	AU10 S30323C	AU10 S30323D
	40A	3	AU10 S30403B	AU10 S30403C	AU10 S30403D
	50A	3	AU10 S30503B	AU10 S30503C	AU10 S30503D
	63A	3	AU10 S30633B	AU10 S30633C	AU10 S30633D















Description	Rating	Module	Cat. Nos.		
			B Curve	C Curve	D Curve
Four Pole  	0.5A	4	-	AU10 S40E53C	AU10 S40E53D
	1A	4	-	AU10 S40013C	AU10 S40013D
	1.6A	4	-	AU10 S41E63C	AU10 S41E63D
	2A	4	-	AU10 S40023C	AU10 S40023D
	3A	4	-	AU10 S40033C	AU10 S40033D
	4A	4	-	AU10 S40043C	AU10 S40043D
	5A	4	-	AU10 S40053C	AU10 S40053D
	6A	4	AU10 S40063B	AU10 S40063C	AU10 S40063D
	10A	4	AU10 S40103B	AU10 S40103C	AU10 S40103D
	16A	4	AU10 S40163B	AU10 S40163C	AU10 S40163D
	20A	4	AU10 S40203B	AU10 S40203C	AU10 S40203D
	25A	4	AU10 S40253B	AU10 S40253C	AU10 S40253D
	32A	4	AU10 S40323B	AU10 S40323C	AU10 S40323D
	40A	4	AU10 S40403B	AU10 S40403C	AU10 S40403D
	50A	4	AU10 S40503B	AU10 S40503C	AU10 S40503D
	63A	4	AU10 S40633B	AU10 S40633C	AU10 S40633D
SPN  	0.5A	2	-	AU10 SS0E53C	AU10 SS0E53D
	1A	2	-	AU10 SS0013C	AU10 SS0013D
	1.6A	2	-	AU10 SS1E63C	AU10 SS1E63D
	2A	2	-	AU10 SS0023C	AU10 SS0023D
	3A	2	-	AU10 SS0033C	AU10 SS0033D
	4A	2	-	AU10 SS0043C	AU10 SS0043D
	5A	2	-	AU10 SS0053C	AU10 SS0053D
	6A	2	AU10 SS0063B	AU10 SS0063C	AU10 SS0063D
	10A	2	AU10 SS0103B	AU10 SS0103C	AU10 SS0103D
	16A	2	AU10 SS0163B	AU10 SS0163C	AU10 SS0163D
	20A	2	AU10 SS0203B	AU10 SS0203C	AU10 SS0203D
	25A	2	AU10 SS0253B	AU10 SS0253C	AU10 SS0253D
	32A	2	AU10 SS0323B	AU10 SS0323C	AU10 SS0323D
	40A	2	AU10 SS0403B	AU10 SS0403C	AU10 SS0403D
	50A	2	AU10 SS0503B	AU10 SS0503C	AU10 SS0503D
	63A	2	AU10 SS0633B	AU10 SS0633C	AU10 SS0633D
TPN  	0.5A	4	-	AU10 ST0E53C	AU10 ST0E53D
	1A	4	-	AU10 ST0013C	AU10 ST0013D
	1.6A	4	-	AU10 ST1E63C	AU10 ST1E63D
	2A	4	-	AU10 ST0023C	AU10 ST0023D
	3A	4	-	AU10 ST0033C	AU10 ST0033D
	4A	4	-	AU10 ST0043C	AU10 ST0043D
	5A	4	-	AU10 ST0053C	AU10 ST0053D
	6A	4	AU10 ST0063B	AU10 ST0063C	AU10 ST0063D
	10A	4	AU10 ST0103B	AU10 ST0103C	AU10 ST0103D
	16A	4	AU10 ST0163B	AU10 ST0163C	AU10 ST0163D
	20A	4	AU10 ST0203B	AU10 ST0203C	AU10 ST0203D
	25A	4	AU10 ST0253B	AU10 ST0253C	AU10 ST0253D
	32A	4	AU10 ST0323B	AU10 ST0323C	AU10 ST0323D
	40A	4	AU10 ST0403B	AU10 ST0403C	AU10 ST0403D
	50A	4	AU10 ST0503B	AU10 ST0503C	AU10 ST0503D
	63A	4	AU10 ST0633B	AU10 ST0633C	AU10 ST0633D

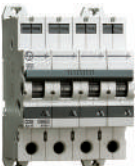

Product Range- Quick Connect
AU-10 | 10kA as per IS/IEC 60898-1



Description	Rating	Module	Cat. Nos.	
			B Curve	C Curve
 <p>Single Pole</p> 	6A	1	AU10 Q10063B	AU10 Q10063C
	10A	1	AU10 Q10103B	AU10 Q10103C
	16A	1	AU10 Q10163B	AU10 Q10163C
	20A	1	AU10 Q10203B	AU10 Q10203C
 <p>Two Pole</p> 	6A	2	AU10 Q20063B	AU10 Q20063C
	10A	2	AU10 Q20103B	AU10 Q20103C
	16A	2	AU10 Q20163B	AU10 Q20163C
	20A	2	AU10 Q20203B	AU10 Q20203C
 <p>Three Pole</p> 	6A	3	AU10 Q30063B	AU10 Q30063C
	10A	3	AU10 Q30103B	AU10 Q30103C
	16A	3	AU10 Q30163B	AU10 Q30163C
	20A	3	AU10 Q30203B	AU10 Q30203C
 <p>Four Pole</p> 	6A	4	AU10 Q40063B	AU10 Q40063C
	10A	4	AU10 Q40103B	AU10 Q40103C
	16A	4	AU10 Q40163B	AU10 Q40163C
	20A	4	AU10 Q40203B	AU10 Q40203C
 <p>SPN</p> 	6A	2	AU10 QS0063B	AU10 QS0063C
	10A	2	AU10 QS0103B	AU10 QS0103C
	16A	2	AU10 QS0163B	AU10 QS0163C
	20A	2	AU10 QS0203B	AU10 QS0203C
 <p>TPN</p> 	6A	4	AU10 QT0063B	AU10 QT0063C
	10A	4	AU10 QT0103B	AU10 QT0103C
	16A	4	AU10 QT0163B	AU10 QT0163C
	20A	4	AU10 QT0203B	AU10 QT0203C

Dimension Details – Quick Connect MCBs

in mm

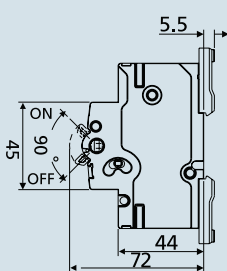

SIDE VIEW

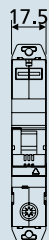

1 POLE



2 POLE / SPN



3 POLE

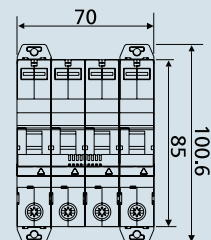









4 POLE / TPN



Product Range- High Rating MCBs
AU-15 | 15kA as per IEC 60947-2



Description	Rating	Module	Cat. Nos.	
			C Curve	D Curve
 <p>Single Pole</p> 	80A	1.5	AU15 S10803C	AU15 S10803D
	100A	1.5	AU15 S11003C	AU15 S11003D
	125A	1.5	AU15 S11253C	AU15 S11253D
 <p>Two Pole</p> 	80A	3	AU15 S20803C	AU15 S20803D
	100A	3	AU15 S21003C	AU15 S21003D
	125A	3	AU15 S21253C	AU15 S21253D
 <p>Three Pole</p> 	80A	4.5	AU15 S30803C	AU15 S30803D
	100A	4.5	AU15 S31003C	AU15 S31003D
	125A	4.5	AU15 S31253C	AU15 S31253D
 <p>Four Pole</p> 	80A	6	AU15 S40803C	AU15 S40803D
	100A	6	AU15 S41003C	AU15 S41003D
	125A	6	AU15 S41253C	AU15 S41253D

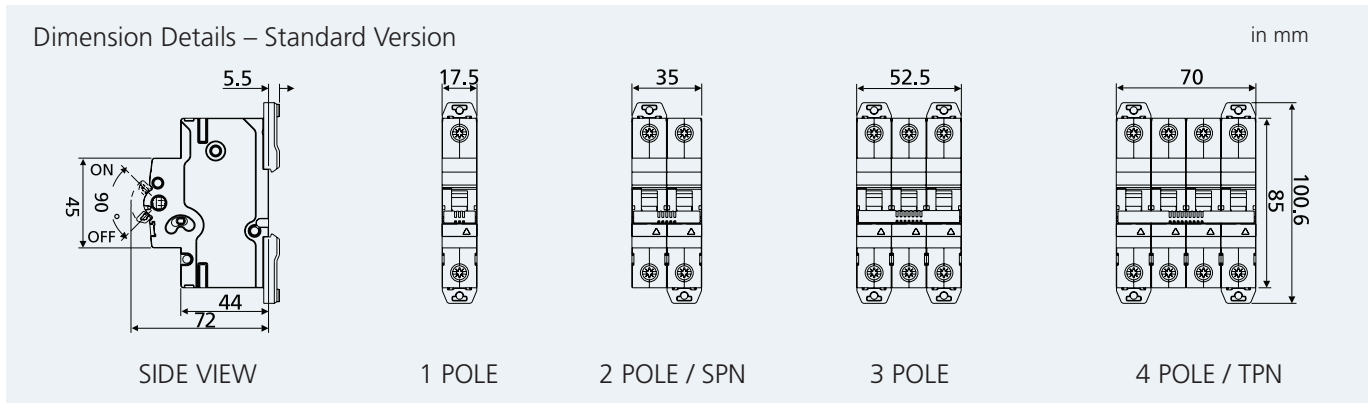
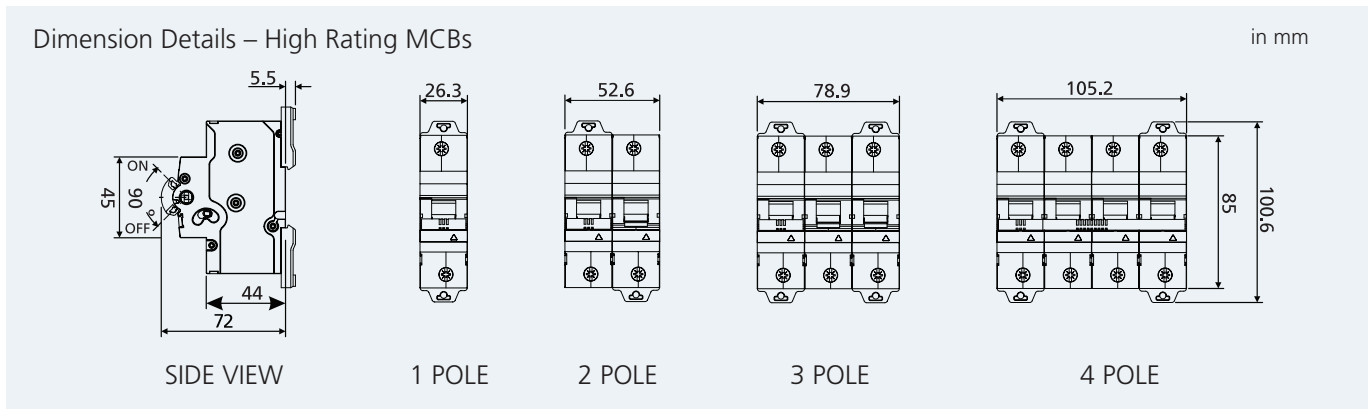



RCCBs - Conditioned for every condition

A sensitivity range from **10mA to 500mA** with Type **AC** and **Adi** (Added Immunity) makes the AU Solutions range of RCCBs suitable for applications ranging from household to industrial.

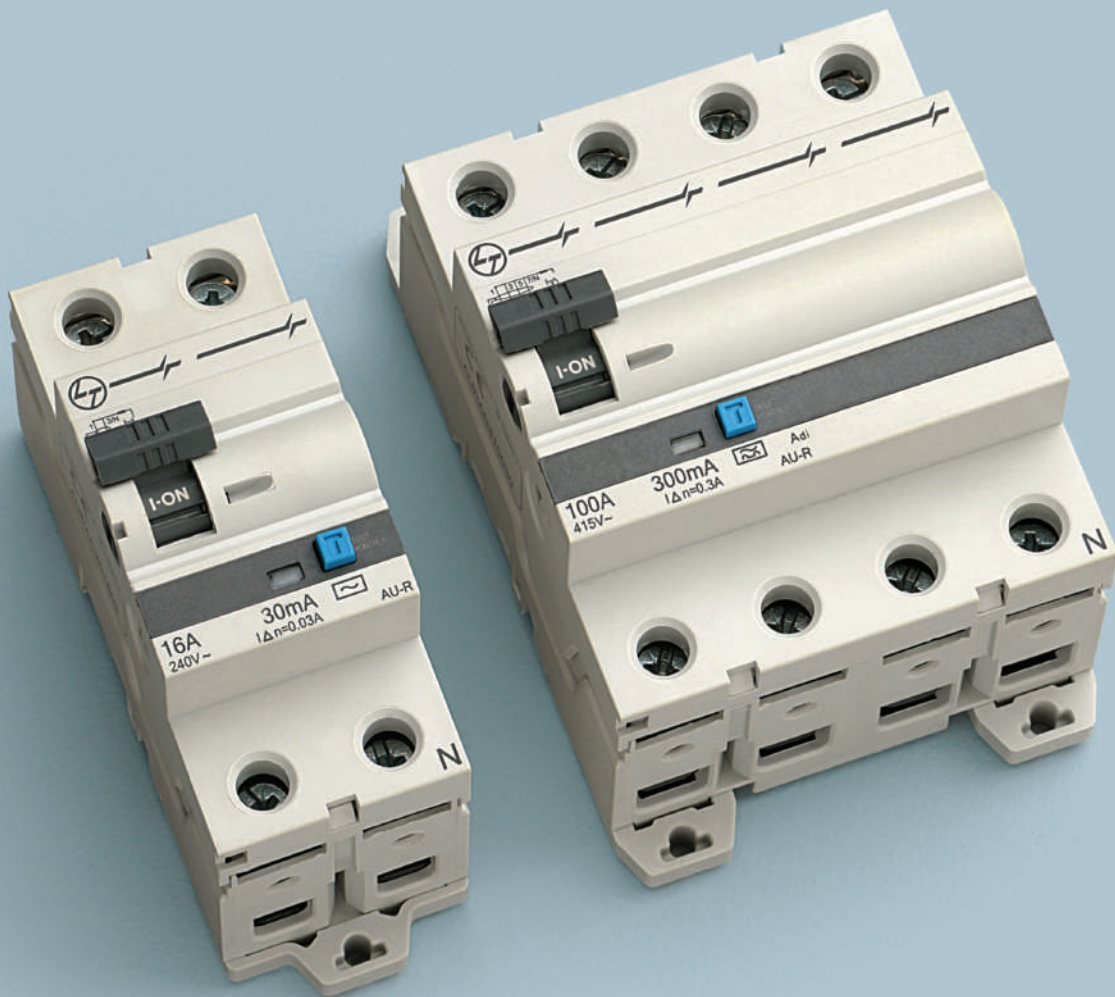



Suitable for varied applications

- Type AC- For standard installations
- Type Adi - For installations with pulsating DC along with transients and harmonics, such as IT parks and data centres

Designed for ease

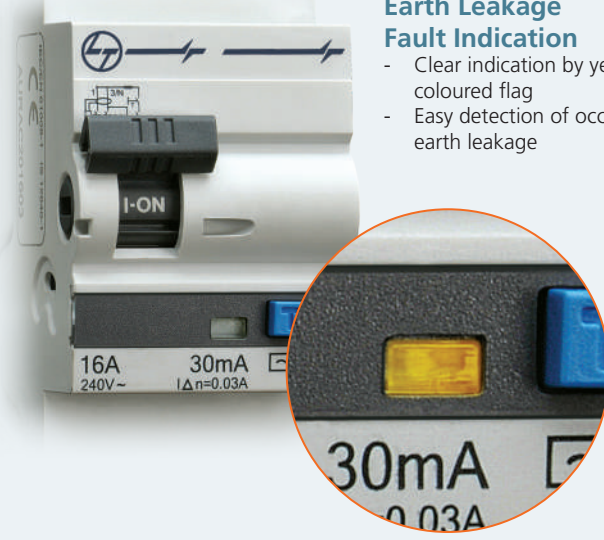

Earth Leakage Fault Indication

- Clear indication by yellow coloured flag
- Easy detection of occurrence of earth leakage

Flexibility

- **Flexibility in Termination**
 - Bi-connect terminals offer busbar or cable termination at both incoming and outgoing sides
- **Line-Load Reversibility**
 - Either of the sides of an RCCB can be used to terminate supply or load
- **RCCBs removability with busbar in place**
 - This feature, with a uniquely designed DIN clip, offers easy removal of DIN mounted RCCBs while the connection busbar is in place with adjoining devices
 - Offers great flexibility in installation process
 - Reduces installation time

Engineered for safety



Ensures Safe Installation

- **Safety Shutter**
 - Avoids incorrect cable insertion, ensuring safe installation



Prevents Unauthorized Access

- **Provision for Padlock**
 - A padlock can be used either in ON or OFF position to meet specific requirements

Trip-free Mechanism

- Ensures reliable and safe product functioning

Advanced Neutral Mechanism

- This feature prevents voltage unbalance in the system, thus protecting equipment downstream



Range Highlights

- Conforms to IEC 61008-1, EN 61008-1, IS 12640-1
- Wide range of current ratings – 16A to 100A
- Precise sensitivities for a variety of applications - from 10mA to 500mA
- Available in
 - Type AC
 - Type Adi
- 2P & 4P versions
- Suitable for Isolation
- Protection Degree - IP 20
- Availability for a wide range of site mountable accessories

Product Specifications

ELECTRICAL	
Rated Operational Voltage	240/415V
Rated Insulation Voltage	500V
Rated Impulse Voltage	6kV
Rated Frequency	50Hz & 60Hz*
Rated Residual Making & Breaking capacity	1kA
Rated Conditional SC Current	10kA
Electrical Life (Operating Cycles)	10,000

GENERAL	
Operating Temperature	AC Type: -25°C to +60°C Adi Type: -25°C to +60°C

MECHANICAL	
Mechanical Life (Operating Cycles)	20,000
Vibration Resistance (in X, Y, Z direction)	1.5g, 30min, 5-80Hz
Shock Resistance (in X, Y, Z direction)	20g, 3 Shocks, with short duration of 5ms

INSTALLATION	
Pollution Degree	3
Terminal Capacity	35 mm ² (rigid) / 25 mm ² (flexible) } up to 63A 50 mm ² (rigid) / 35 mm ² (flexible) } 80A to 100A
Tightening Torque	4Nm
Mounting Position	Horizontal / Vertical / Flat

*For 60Hz requirement, Please contact nearest sales branch

Decoding Product CAT Nos.: AU-R

RCCB	AU R					
TYPE	AC AC	AD Adi				
Number of Poles	2 2 Pole	4 4 Pole				
Rating (A)	016 16A	025 25A	040 40A	063 63A	080 80A	100 100A
Sensitivity	01 10mA	03 30mA	10 100mA	30 300mA	50 500mA	

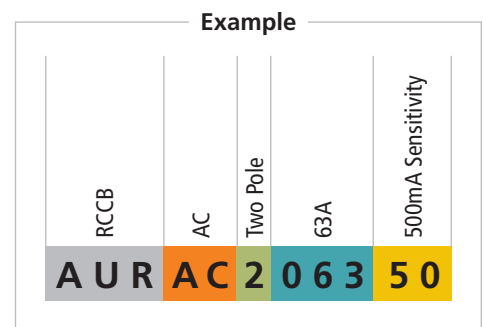



Product Range: AU-R



Description	Type	Rating	Module	10 mA	30 mA	100 mA	300 mA	500 mA
 Two Pole	2P AC	16A	2	AURAC201601	-	-	-	-
		25A	2	-	AURAC202503	AURAC202510	AURAC202530	AURAC202550
		40A	2	-	AURAC204003	AURAC204010	AURAC204030	AURAC204050
		63A	2	-	AURAC206303	AURAC206310	AURAC206330	AURAC206350

 Four Pole	4P AC	25A	4	-	AURAC402503	AURAC402510	AURAC402530	AURAC402550
		40A	4	-	AURAC404003	AURAC404010	AURAC404030	AURAC404050
		63A	4	-	AURAC406303	AURAC406310	AURAC406330	AURAC406350



Description	Type	Rating	Module	10 mA	30 mA	100 mA	300 mA	500 mA
Two Pole	2P	80A	2	-	AURAC208003	AURAC208010	AURAC208030	-
	AC	100A	2	-	AURAC210003	AURAC210010	AURAC210030	-

Description	Type	Rating	Module	10 mA	30 mA	100 mA	300 mA	500 mA
Four Pole	4P	80A	4	-	AURAC408003	AURAC408010	AURAC408030	AURAC408050
	AC	100A	4	-	AURAC410003	AURAC410010	AURAC410030	AURAC410050

Description	Type	Rating	Module	10 mA	30 mA	100 mA	300 mA	500 mA
 Two Pole	2P Adi	25A	2	-	AURAD202503	AURAD202510	AURAD202530	-
		40A	2	-	AURAD204003	AURAD204010	AURAD204030	-
		63A	2	-	AURAD206303	AURAD206310	AURAD206330	-
		100A	2	-	AURAD210003	-	-	-

 Four Pole	4P Adi	25A	4	-	AURAD402503	AURAD402510	AURAD402530	-
		40A	4	-	AURAD404003	AURAD404010	AURAD404030	-
		63A	4	-	AURAD406303	AURAD406310	AURAD406330	-
		100A	4	-	AURAD410003	-	AURAD410030	-

Circuit Diagram

Two Pole

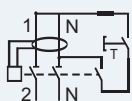

Four Pole

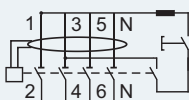

Dimension Details – RCCBs

in mm

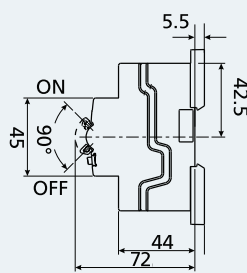

SIDE VIEW



2 POLE

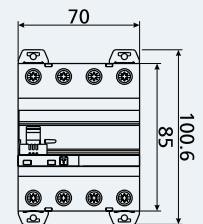

4 POLE



RCBOs - Enhanced Safety

The AU Solutions range RCBOs provides protection from overload, short-circuit and earth leakage.

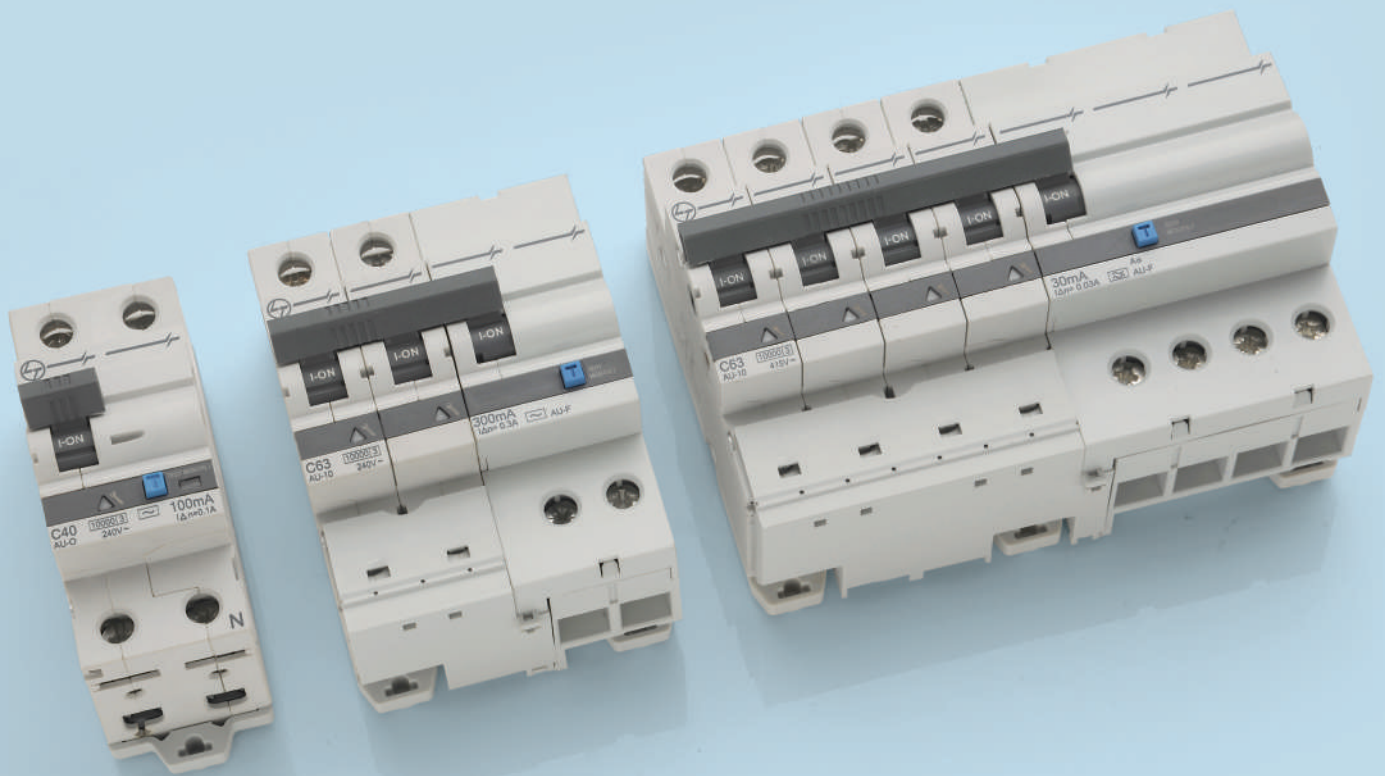



Benefits you can count on

Greater Convenience

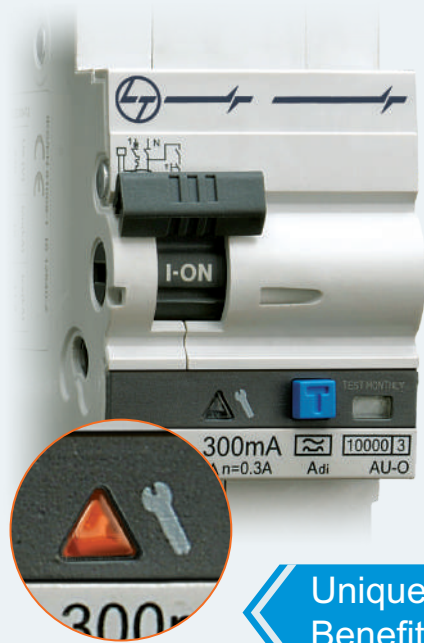

Unique Benefit

- **Short-circuit Fault Indication**
 - Indicates that the breaker has tripped on a short-circuit fault
 - Clear indication by amber coloured flag
 - Easy detection of occurrence of short-circuit fault

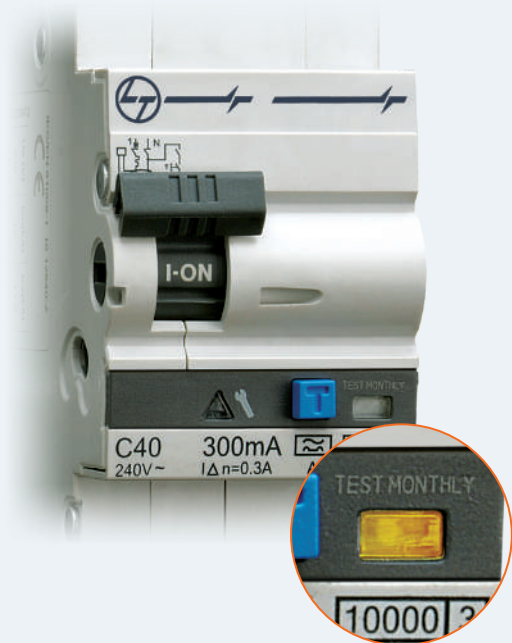

- **Earth Leakage Fault Indication**
 - To indicate that the device has tripped due to an earth leakage
 - Clear indication by yellow coloured flag (2 Pole, 2 Module); indication through knob in others
 - Easy detection of occurrence of earth leakage

Flexibility

- **Flexibility In Termination**
 - For Compact 2 Pole 2 Mod RCBOs, bi-connect terminals offer busbar or cable termination at both incoming and outgoing sides
- **Line-load Reversibility**
 - For compact 2 Pole 2 Mod RCBOs, either of the sides of the RCBO can be used to terminate supply or load
 - For other RCBO variants, MCB side is recommended as incoming and RCD side as outgoing, ensuring backup protection to RCD section
- **RCBOs Removability with Busbar in Place**
 - This feature, with uniquely designed DIN clip, offers easy removal of DIN-mounted RCBOs while connection busbar is in place with adjoining devices
 - Reduces installation time



Reliability at every touch-point

Higher Reliability



Ensures Safe Installation

- **Safety Shutter**
 - Avoids incorrect cable insertion



True Position Indication

- Position of a knob indicates actual position of the contacts inside, ensuring customer safety



Prevents Unauthorized Access

- **Provision for Padlock**
 - Can be used either in ON or OFF position to meet specific customer requirements

Trip-free Mechanism

- Ensures reliable and safe product functioning



+



=



MCB
Overload + Short-circuit
Protection

RCCB
Earth Leakage
Protection

RCBO
Overload + Short-circuit + Earth Leakage
= 3-in-1 Protection



Range Highlights

- Conforms to IEC 61009-1, IS12640-2, EN 61009-1
- Available in
 - Type AC – For standard installations
 - Type Adi – For installations with presence of pulsating DC along with transients and harmonics
- Wide range of current ratings – 6A to 100A
- Precise sensitivities for a variety of applications – from 10mA to 300mA
- 2P & 4P versions
- Suitable for Isolation
- Protection Degree - IP 20
- Availability of wide range of site-mountable accessories

Product Specifications

ELECTRICAL	
Rated Operational Voltage	240/415V
Rated Insulation Voltage	500V
Rated Impulse Voltage	6kV
Rated Frequency	50Hz & 60Hz*
Rated Residual Making & Breaking capacity	500A (16A to 40A) 630A (63A) 1kA (80A & 100A)
Rated Short-circuit Breaking Capacity	10kA
Electrical Life (Operating Cycles)	10,000 (6A to 63A) 5,000 (80A to 100A)

GENERAL	
Operating Temperature	AC Type: -25°C to +60°C Adi Type: -25°C to +60°C

MECHANICAL	
Mechanical Life (Operating Cycles)	20,000
Vibration Resistance (in X, Y, Z direction)	1.5g, 30min, 5-80Hz
Shock Resistance (in X, Y, Z direction)	10g, 3 Shocks, with short duration of 10ms

INSTALLATION	
Pollution Degree	3
Terminal Capacity	35 mm ² (rigid) 25 mm ² (flexible) } up to 63A 70 mm ² (rigid) 50 mm ² (flexible) } 80A to 100A
Tightening Torque	4Nm
Mounting Position	Horizontal / Vertical / Flat

*For 60Hz requirement, Please contact nearest sales branch

Decoding Product CAT Nos: AU-O

Range	AU										
Standard	F	Standard, C Curve									
Calibration	3 30 deg	4 40 deg 5 50 deg									
Type	C AC	D Adi									
Number of Poles	2 2 Pole	4 4 Pole									
Rating (A)	006 6A	010 10A	016 16A	020 20A	025 25A	032 32A	040 40A	050 50A	063 63A	080 80A	100 100A
Sensitivity	01 10mA	03 30mA	10 100mA	30 300mA							

Example

	Standard, C Curve 30 deg	AC	Two Pole	6A	30mA		
A	U	F	3	C	2	006	03



Product Range: AU-O, AU-F

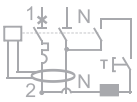

Description		Rating	Module	10mA	30mA	100mA	300mA
Type AC 2P  	6A	2	AUF3C200601	AUF3C200603	AUF3C200610	AUF3C200630	
	10A	2	AUF3C201001	AUF3C201003	AUF3C201010	AUF3C201030	
	16A	2	-	AUF3C201603	AUF3C201610	AUF3C201630	
	20A	2	-	AUF3C202003	AUF3C202010	AUF3C202030	
	25A	2	-	AUF3C202503	AUF3C202510	AUF3C202530	
	32A	2	-	AUF3C203203	AUF3C203210	AUF3C203230	
	40A	2	-	AUF3C204003	AUF3C204010	AUF3C204030	
	63A	4	-	AUF3C206303	AUF3C206310	AUF3C206330	

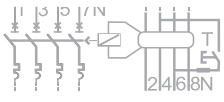
Type AC 4P  	16A	7.5	-	AUF3C401603	AUF3C401610	AUF3C401630
	20A	7.5	-	AUF3C402003	AUF3C402010	AUF3C402030
	25A	7.5	-	AUF3C402503	AUF3C402510	AUF3C402530
	32A	7.5	-	AUF3C403203	AUF3C403210	AUF3C403230
	40A	7.5	-	AUF3C404003	AUF3C404010	AUF3C404030
	63A	7.5	-	AUF3C406303	AUF3C406310	AUF3C406330
	80A	12	-	AUF3C408003	AUF3C408010	AUF3C408030
	100A	12	-	AUF3C410003	AUF3C410010	AUF3C410030

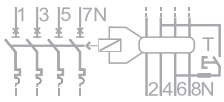

Type Adi 2P  	6A	2	-	AUF3D200603	AUF3D200610	AUF3D200630
	10A	2	-	AUF3D201003	AUF3D201010	AUF3D201030
	16A	2	-	AUF3D201603	AUF3D201610	AUF3D201630
	20A	2	-	AUF3D202003	AUF3D202010	AUF3D202030
	25A	2	-	AUF3D202503	AUF3D202510	AUF3D202530
	32A	2	-	AUF3D203203	AUF3D203210	AUF3D203230
	40A	2	-	AUF3D204003	AUF3D204010	AUF3D204030
	63A	4	-	AUF3D206303	AUF3D206310	AUF3D206330

Type Adi 4P  	16A	7.5	-	AUF3D401603	AUF3D401610	AUF3D401630
	20A	7.5	-	AUF3D402003	AUF3D402010	AUF3D402030
	25A	7.5	-	AUF3D402503	AUF3D402510	AUF3D402530
	32A	7.5	-	AUF3D403203	AUF3D403210	AUF3D403230
	40A	7.5	-	AUF3D404003	AUF3D404010	AUF3D404030
	63A	7.5	-	AUF3D406303	AUF3D406310	AUF3D406330
	80A	12	-	AUF3D408003	AUF3D408010	AUF3D408030
	100A	12	-	AUF3D410003	AUF3D410010	AUF3D410030

Dimension Details - RCBO

in mm

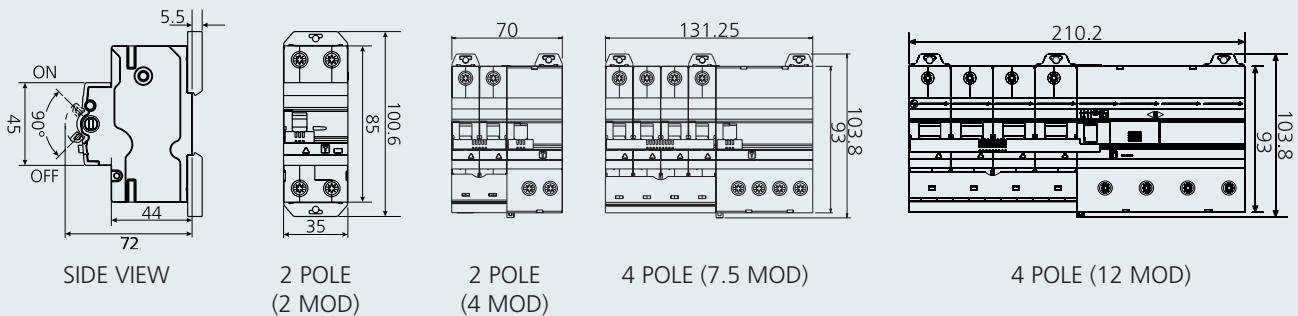



SPDs - Safety against surges

SPDs provide protection to electrical/electronic equipment against a brief overvoltage spike or disturbance on a power/signal waveform called a surge. The AU Solutions range of SPDs provides protection against lightning and switching surges.

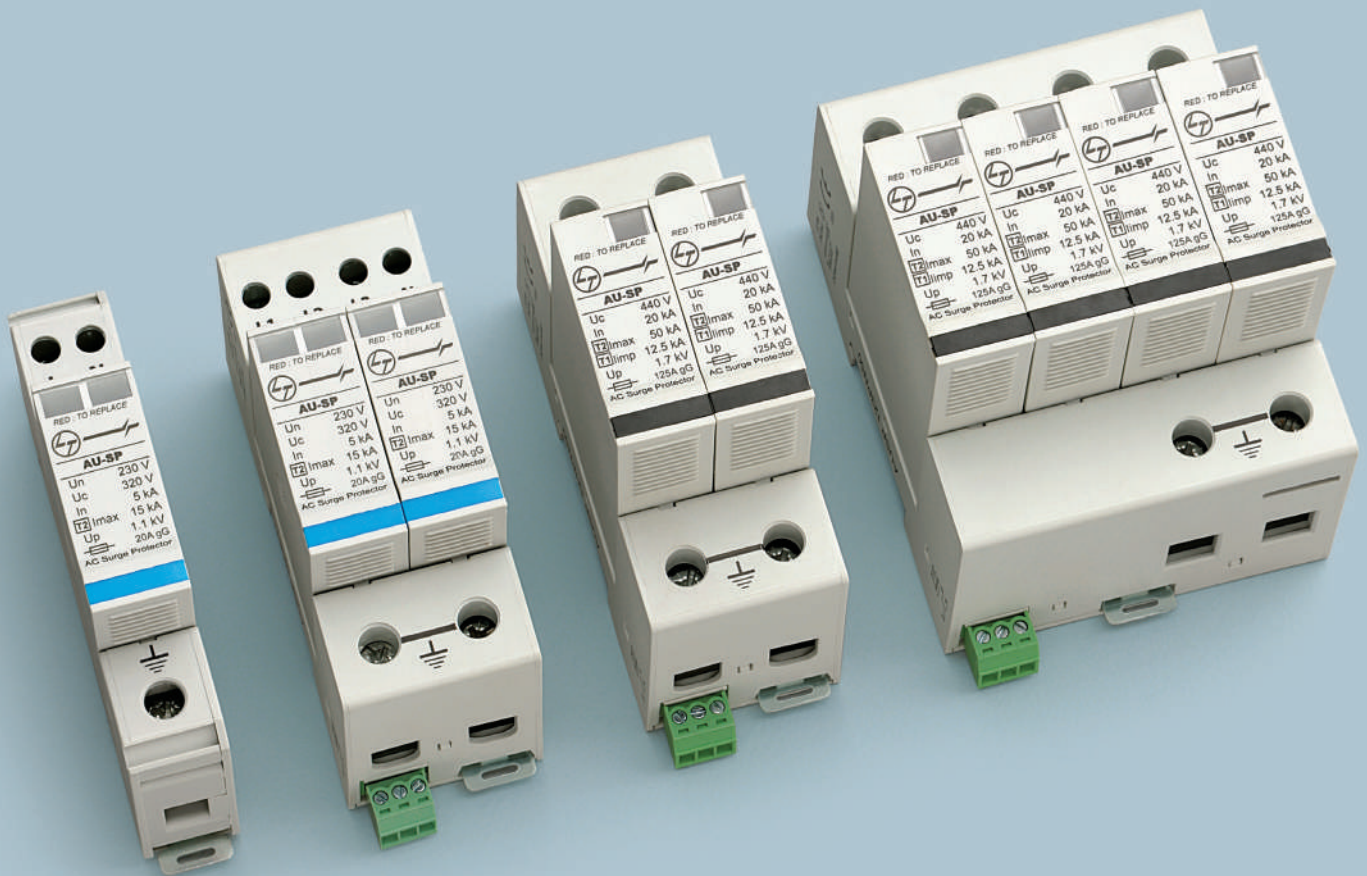

AU-SP Range of SPDs



Protects sensitive equipment,
minimizes costly downtime

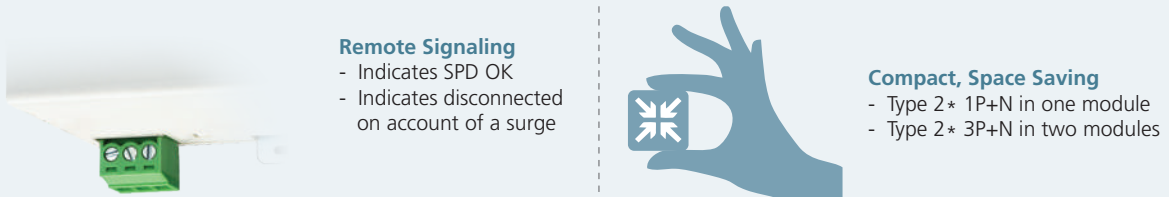
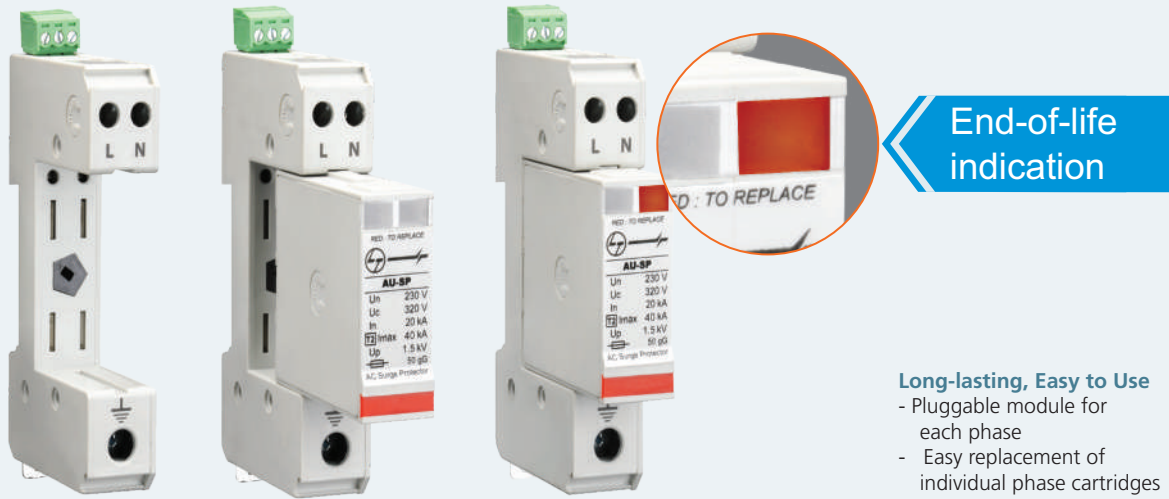

Range Highlights

- Conforms to IEC 61643-11
- Available in Type 2 and Type 1+2
- Type 2 : Protection against indirect lightning and switching surges
 - Maximum Discharge Current – I_{max} up to 70kA
- Type 1+2 : Protection against direct and indirect lightning surges
 - Maximum Discharge Current – I_{max} up to 100kA

T* Type 2 SPDs with I_{max} 40kA & 15kA



Product Specifications

	Type 1+2 SPDs			
	AUSP 121PN50	AUSP 123PN50	AUSP 121PN100	AUSP 123PN100
Operating voltage	230/400V			
Maximum Operating Voltage U_c	440 VAC			
TOV/withstand U_T	770 VAC			
Operating Current I_c	<1 mA			
Nominal Discharge Current I_n 15X 8/20 micro second	20kA		30kA	
Maximum Discharge Current I_{max} Maximum withstand 8/20 micro second	50kA		100kA	
Max. lightning Current by Pole I_{imp} Max withstand at 10/350 micro second	12.5kA		8kA	
Protection Level U_p	1.7kV		1.8kV	
Admissible Short Circuit Current	25000A			
Back up Fuses	Fuses type gG - 125A max		Fuses type gG - 100A max	
Terminal Capacity	2.5 - 25 mm ²			
Disconnection Indicator (per pole)	1 Mechanical Indicator		2 Mechanical Indicator	
Remote Signalling	Output on changeover contact			
Operating Temperature	-40°C to 85°C			
Protection Degree	IP 20			
Dimension (HxWxD)	90 mm x 36 mm x 67 mm	90 mm x 72 mm x 67 mm	90 mm x 36 mm x 67 mm	90 mm x 72 mm x 67 mm

	Type 2 SPDs					
	AUSP021PN40	AUSP023PN40	AUSP021PN15	AUSP023PN15	AUSP021PN70	AUSP023PN70
Operating voltage	230V/400V					
Maximum Operating Voltage U_c	320 VAC					
TOV/withstand U_T	770 VAC				335 VAC	
Operating Current I_c	<1 mA					
Nominal Discharge Current I_n 15 x 8/20 micro second	20kA		5kA		30kA	
Maximum Discharge Current I_{max} Maximum withstand 8/20 micro second	40kA		15kA		70kA	
Protection Level U_p	1.5 kV		1.1 kV		1.6 kV	
Admissible Short Circuit Current	10000A				25000A	
Back up Fuses	Fuse type gG - 50A max		Fuse type gG - 25A max		Fuse type gG - 100A max	
Terminal Capacity	L/N 1.5 - 10 mm ² and PE 2.5 - 25 mm ²				2.5 - 25 mm ²	
Disconnection Indicator (per pole)	2 Mechanical Indicators					
Remote Signalling	Output on changeover contact					
Operating Temperature	-40°C to 85°C					
Protection Degree	IP 20					
Dimension (HxWxD)	90 mm x 18 mm x 67 mm	90 mm x 36 mm x 67 mm	90 mm x 18 mm x 67 mm	90 mm x 36 mm x 67 mm	90 mm x 36 mm x 67 mm	90 mm x 72 mm x 67 mm



Decoding Product Cat. Nos.: AU-SP



SPD → **AU SP**

Type → **02** Type 2 **12** Type 1+2



Number of Poles → **1PN** 1 P+N **3PN** 3 P+N

Rating (kA) → **15** 15kA **50** 50kA **40** 40kA
 70 70kA **100** 100kA

Example

Surge Protection Device	Type 1+Type 2	1 Pole+N	50kA
A	U	S	P
	12	1PN	50

Product Range: AU-SP

Description	Configuration	Modules	Cat. Nos.
 Type 1+2, I _{max} 50kA	1P+N	2	AUSP 121PN50
	3P+N	4	AUSP 123PN50
	1P+N	2	AUSP121PN100
	3P+N	4	AUSP123PN100
 Type 2, I _{max} 40kA	1P+N	1	AUSP 021PN40
	3P+N	2	AUSP 023PN40
	1P+N	2	AUSP021PN70
	3P+N	4	AUSP023PN70
 Type 2, I _{max} 15kA	1P+N	1	AUSP 021PN15
	3P+N	2	AUSP 023PN15

Cartridges for SPDs

Description	Cat. Nos.
Cartridge for AUSP021PN15	AUSC021PN15
Cartridge for AUSP021PN40	AUSC021PN40
Cartridge for AUSP021PN70 /AUSP023PN70	AUSC021PN70
Cartridge for AUSP023PN15	AUSC023PN15
Cartridge for AUSP023PN40	AUSC023PN40
Cartridge for AUSP121PN100 /AUSP123PN100	AUSC121PN100
Cartridge for AUSP121PN50 / AUSP123PN50	AUSC121PN50

SPD Back-up Protection Details

Type 1+2 & Type 2 -70kA

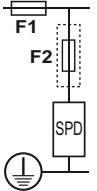

Fuse max.
F1 > 160 A ↓ F2 ≤ 160 A
F1 ≤ 160 A ↓ No F2

Type 2

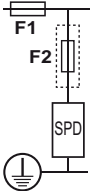

15kA	40kA
*Fuse max	*Fuse max
F1 > 40 A ↓ F2 ≤ 40 A	F1 > 125 A ↓ F2 ≤ 125 A
F1 ≤ 40 A ↓ No F2	F1 ≤ 125 A ↓ No F2



MONITORING DEVICES

The AU Solutions range of protection devices are complemented by a host of monitoring devices.

Accessories

- Auxiliary Contact (AUX)
- Auxiliary / Trip Alarm Contact (AUX/TAC)
- Undervoltage Release (UV)
- Overvoltage Release (OV)
- Shunt Release (SR)
- Padlocks

Energy Meters

- Single-phase
- Three-phase

Indicating Lights

- For single-phase and three-phase supply

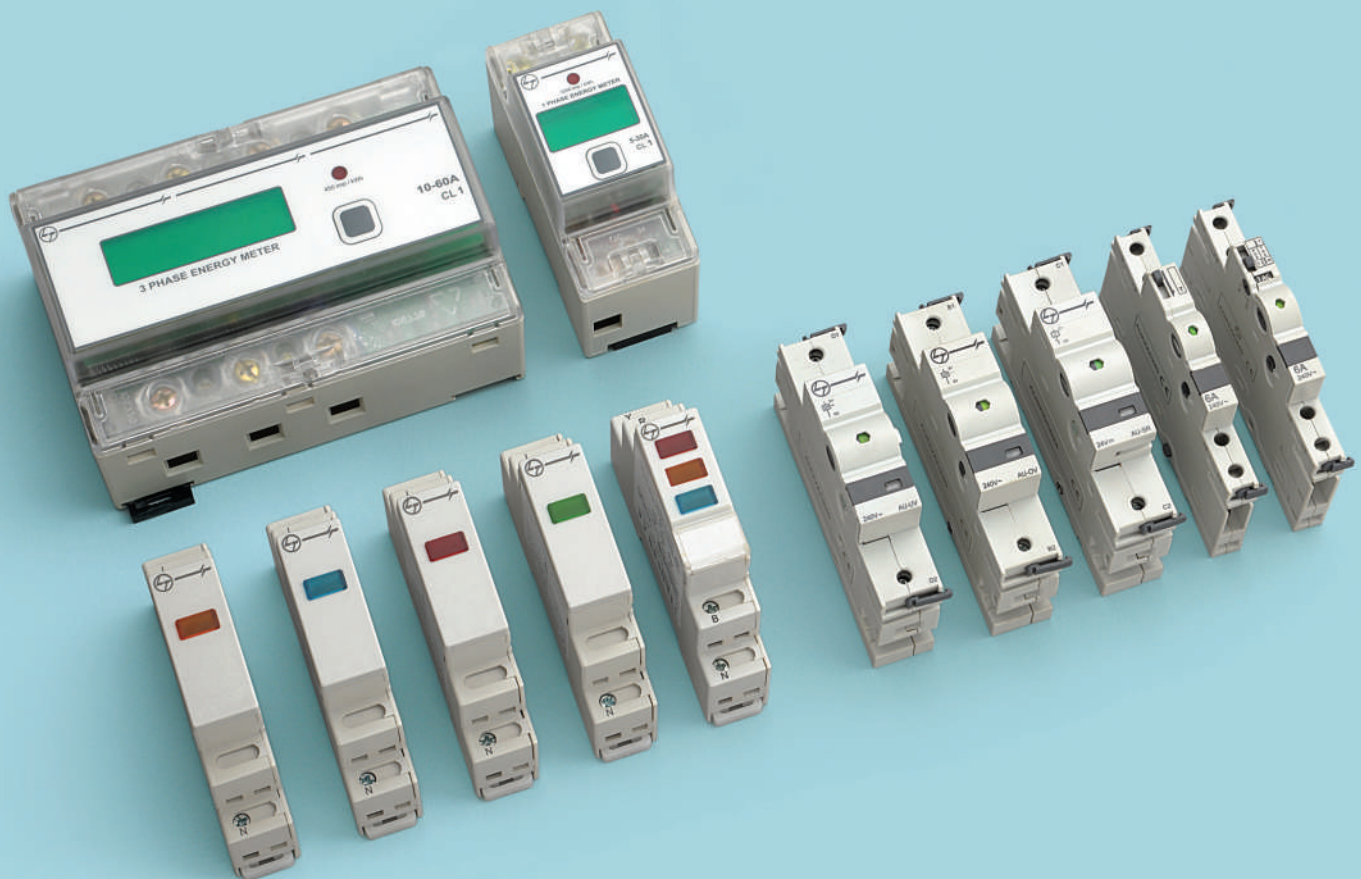



Accessories - The freedom to choose

With the AU Solutions range, you can select from a common set of accessories for RCCBs, RCBOs, MCBs and Isolators.

- Auxiliary Contact (AUX)
- Auxiliary / Trip Alarm Contact (AUX/TAC)
- Undervoltage Release (UV)
- Overvoltage Release (OV)
- Shunt Release (SR)
- Padlocks

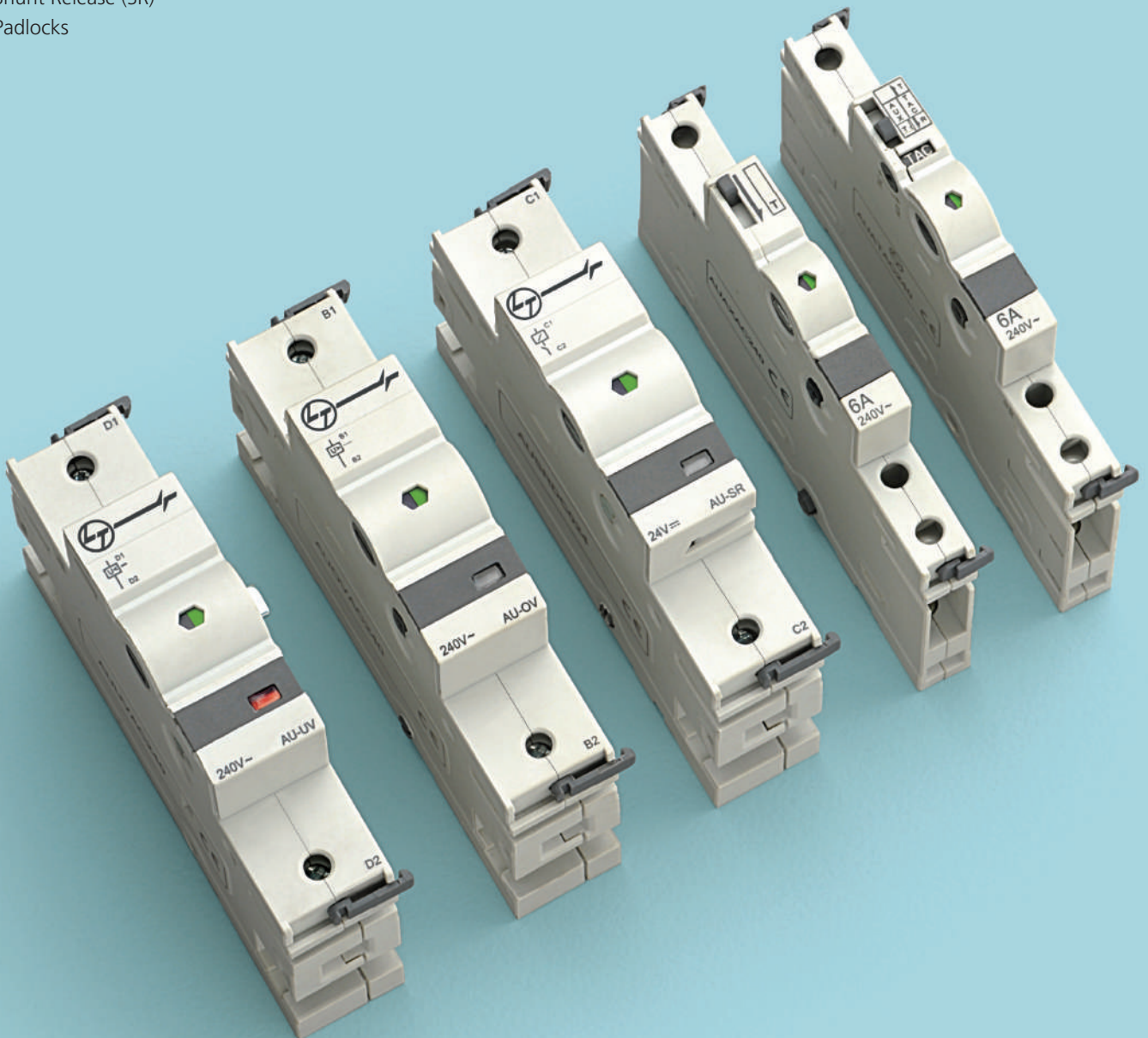



A common set of accessories, with uncommon benefits

The AU Solutions range of accessories is designed to complement AU MCBs, RCCBs, RCBOs and Isolators.

Increased Flexibility

One Mod = 17.5mm
Half Mod = 8.75mm

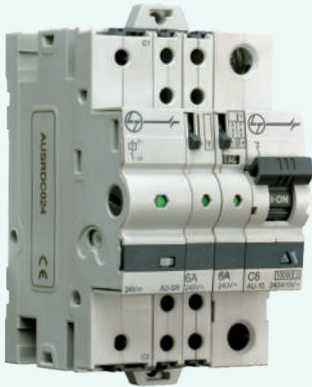

Mounting on the Left Side

- The left side of the MCB, RCCB, RCBO and Isolator has a provision to mount Half Mod and One Mod accessories

Mounting Sequence for Multiple Accessories

- In Half Module Accessories, TAC should be located next to the main device

Mounting for up to 3 Accessories

- 3 Half Mod or 3 One Mod or a combination of both
- All accessories to be stacked on the left side

Enhanced Convenience

• Half Mod Accessories (AU-AX, AU-AT)



Test Button

- Check product functioning without operating the main device

Reset Button

- Available in AU-AT
- Helps to manually acknowledge the actuation of an accessory without affecting the status of the main device

Auxiliary Contact or Trip Alarm Contact

- As per customer requirement
- Flexibility of selection of either AUX or TAC

Actuator:

- When connected in **AUX mode** to main device (main device in OFF condition), actuator in 'UP' position
- When connected in **TAC mode** to main device (main device in OFF condition), actuator in 'DOWN' position

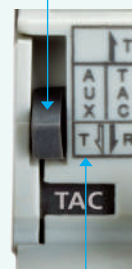

Test for TAC:

- With the accessory in TAC mode, changeover of NO/NC contacts can be checked by moving the actuator to this position

Reset for TAC:

- With the accessory in TAC mode, when the breaker trips, TAC can be reset by moving the actuator to this position

Test For AUX:

- With the accessory in AUX mode, changeover of NO/NC contacts can be checked by moving the actuator to this position

• One Mod Accessories (AU-UV, AU-OV, AU-SR)



- Flag Indicator for 'undervoltage', 'overvoltage' and 'remote-tripping'
- OV, UV: Unique design that prevents reclosing of the associated protection device until the voltage resumes the normal threshold



Range Highlights

- Standard compliance
 - Undervoltage Release – IEC 60947-1
 - Shunt Release – IEC 60947-1
- Protection Degree – IP 20
- Auxiliary Contact (AU-AX) & Selectable Auxiliary/Trip Alarm Contact (AU-AT) are offered in Half Module
- Undervoltage (AU-UV), Overvoltage (AU-OV) and Shunt Release (AU-SR) are offered in One Module
- All Half Module and One Module Accessories are common for MCBs and RCDs
- Padlock is offered in two versions
 - AUPD 01 – suitable for 1Pole = 1Module Devices
 - AUPD 02 – suitable for 1Pole = 1.5 Module Devices

Product Specifications



Electrical				
	AU-AX, AU-AT	AU-OV	AU-SR	AU-UV
	AUX; AUX/TAC	Overvoltage	Shunt Release	Undervoltage Release
Rated Current	6A			
Rated Operational Voltage	240V AC, 24V DC	240V AC	240V AC, 24V DC	
Rated Impulse voltage	4kV			
Rated Frequency	50/60 Hz			
Electrical Life (Operating Cycles)	10,000			
Pick-up Voltage	-	-	-	85% of rated operational Voltage
Drop-off voltage	-	-	-	Between 70% and 35% of Rated Operational Voltage
Trip Threshold Voltage	-	265-280 V AC	-	-
Continuous Consumption	-	Less than 0.9 VA	-	Less than 3VA (for 240V AC)

Installation				
	AU-AX, AU-AT	AU-OV	AU-SR	AU-UV
Terminal Capacity	2.5 sq mm			

General				
	AU-AX, AU-AT	AU-OV	AU-SR	AU-UV
Utilization Category	AC 12	-	-	-
Contact Configuration	1NO + 1NC	-	-	-
Operating Temperature	-25°C to 60°C			











Decoding Product CAT Nos.:
AU-UV, AU-OV, AU-SR, AU-AX, AU-AT

Accessories	AU-UV Undervoltage	AU-OV Overvoltage	AU-SR Shunt Release
	AU-AX Aux Contact	AU-AT Aux/TAC	
AC/DC	AC AC	DC DC	
	240 240V	24 24V	



Example

Accessory	AC/DC	240V
A U U V	A C	2 4 0

Product Range: AU-AX, AU-AT, AU-UV, AU-OV, AU-SR; AU-PD

Description	Configuration	Module	Voltage	Cat. Nos.
 <p>Auxiliary Contact</p> 	1NO+1NC	0.5	240V AC, 24V DC	AUAX AC240
 <p>AUX/TAC</p> 	1NO+1NC 1NO+1NC	0.5 0.5	240V AC, 24V DC 240V AC, 24V DC	AUAT AC240 AUATAC240HR
 <p>Undervoltage Release</p> 	- -	1 1	240V AC 24V DC	AUUV AC240 AUUV DC024
 <p>Overvoltage Release</p> 	-	1	240V AC	AUOV AC240



Description	Configuration	Module	Voltage	Cat. Nos.
 <p>Shunt Release</p> 	-	1	240V AC	AUSRAC240
	-	1	24V DC	AUSR DC024

 <p>Padlock - Suitable for Lock Hasp 3.5 - 5 mm dia. max</p>	Suitable for 1 Pole = 1 Mod devices: MCBs up to 63A, RCCBs, RCBOs, Isolators, Changeover Switches up to 40A	AUPD01
	Suitable for 1 Pole - 1.5 Mod devices: MCBs 80A-125A, Changeover Switch 63A	AUPD02

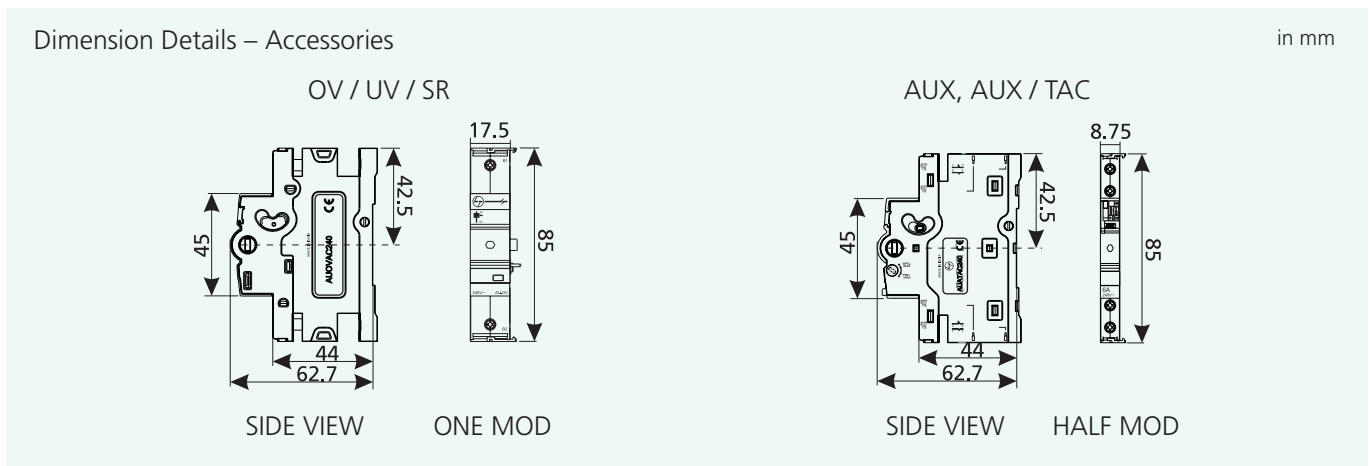



Mounting of Accessories

Termination

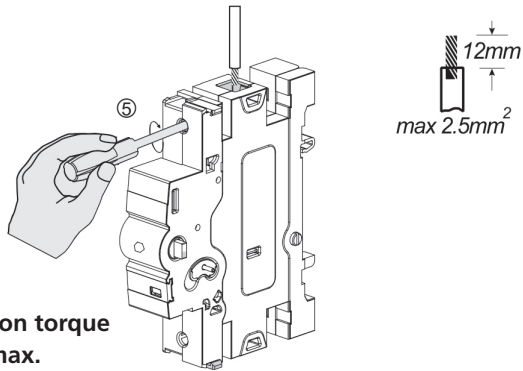

Termination torque
0.5 N-m max.

Mounting

➔MATCH AND FIX THIS ALL 5 POINTS

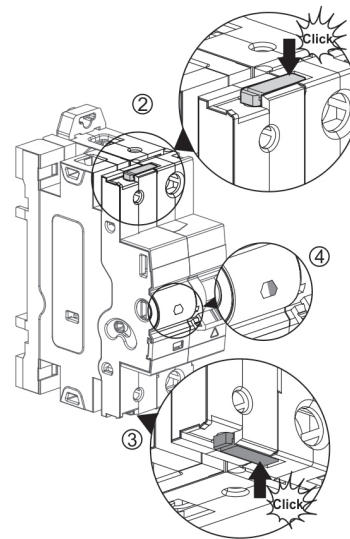
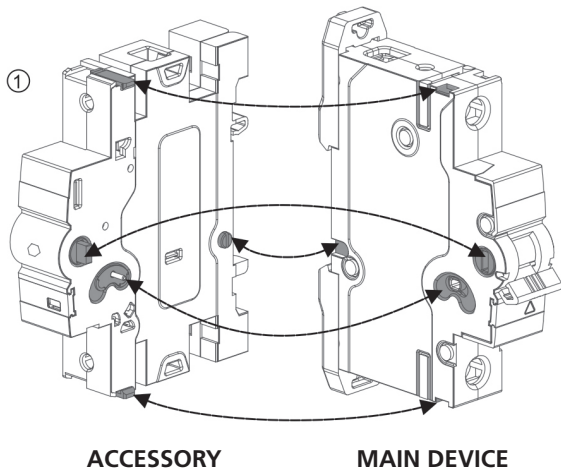

Accessory Fitment

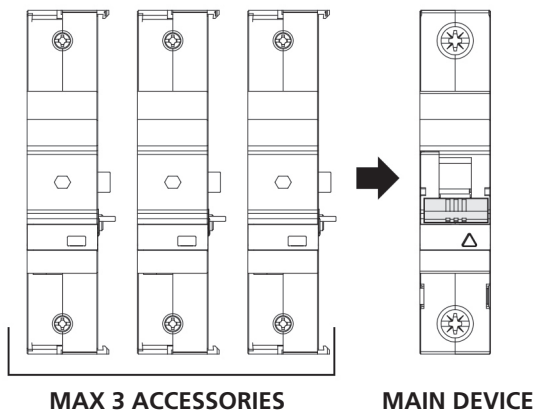

MAX 3 ACCESSORIES

MAIN DEVICE

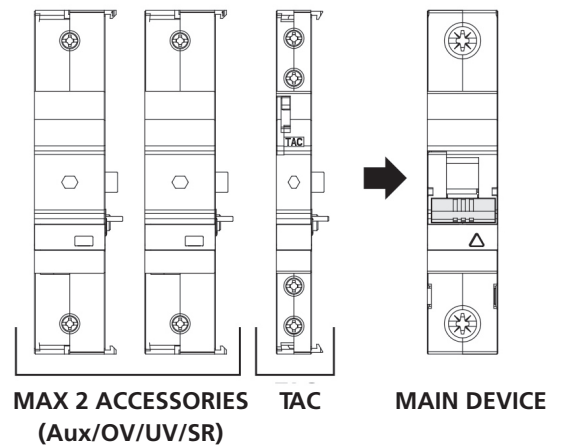

MAX 2 ACCESSORIES
(Aux/OV/UV/SR)

TAC

MAIN DEVICE

Note: 3 Accessories

- ➔ 3 Half Mod* or 3 One Mod or a combination of both
- ➔ Any Combination of OV or UV or Aux or Aux/TAC (Aux mode)

* For RCCB 2 Half Mod

Note:

- ➔ TAC always first



Energy Meters - that talk

The AU Solutions range of Energy Meters is ahead of its time, meeting your need for energy management.





Intelligent and convenient

Energy Meters, available in single-phase and three-phase versions, can be mounted on a DIN rail to monitor power consumption of identified loads, circuits and areas.

Easy Reading

- LCD display
- Displays day, week, month and push-to-push kWh consumption

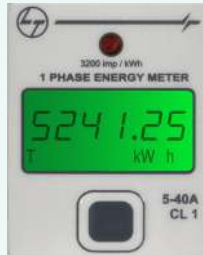

Comfortable Operation

- Pushbutton for parameter scrolling

Effortless mounting

- Compact size, easy DIN rail mounting

Range Highlights

- Communication with the help of RS 485 & WiFi module
- Class 1 accuracy
- Direct current operated meter
- Reverse current indication for three-phase meter

Product Specifications

Parameters		Display Parameters	
		3-Phase meter	1-Phase meter
Instantaneous Parameters	Phase voltage	[[
	Phase current	[[
	Power factor	[-
	Active power	[[
	Reactive power	[-
	Apparent power	[-
	Frequency	[-
Maximum Demand	Present month	[-
	Previous month	[-
kWh Consumption	Total	[[
	Present day	[[
	Present week	[[
	Present month	[[
	Push-to-push	[[
	Previous day	[[
	Previous week	[[
Previous month	[[



Product Specifications

GENERAL		
Display	Type	6 digit LCD
	Height	6 mm (10mm in case of 3Phase meter)
Measuring Circuit	Class of accuracy	Class 1 as per IEC 62053-21
	Measurement circuit burden	<1W, <8VA
	Rated Voltage	240 V
	Current	3 phase: 10-60A
		1 phase: 5-40A
	Starting current	3 phase: 40mA
		1 phase: 20mA
	Voltage range for class of accuracy	-30% to +20% of rated voltage
Current range for class of accuracy	5% I_b to I_{max}	
Input frequency range	50Hz \pm 5%	
Dimensions	Weight	3 phase: 460g (approx.)
		1 phase: 150g (approx.)

Product Range: AU-EM

Description	Module	Cat. Nos.
 Single Phase Three Phase	2	WD4000101000
	7	WD4000103000

Wiring Diagram

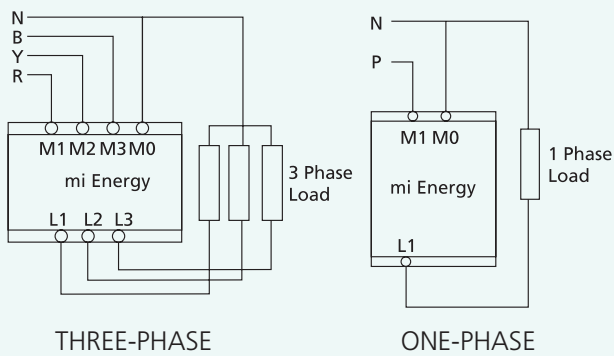

Dimension Details – Energy Meters

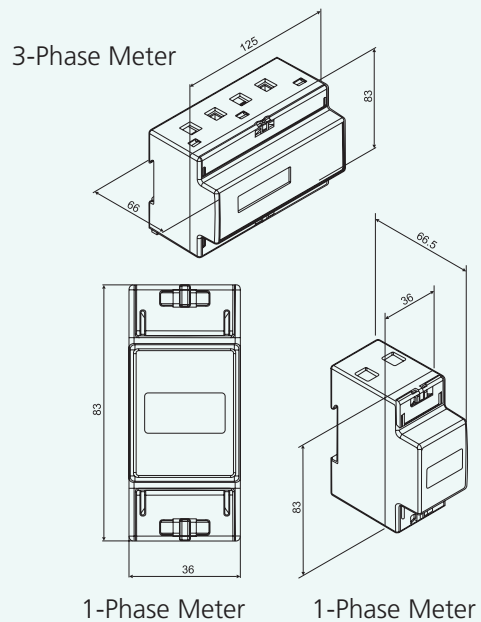



Indicating Lights - Longer life, higher savings

The AU Solutions range of indicating lights uses LED technology, known for its low power consumption. Indicating lights show the status of the supply in the electrical system.

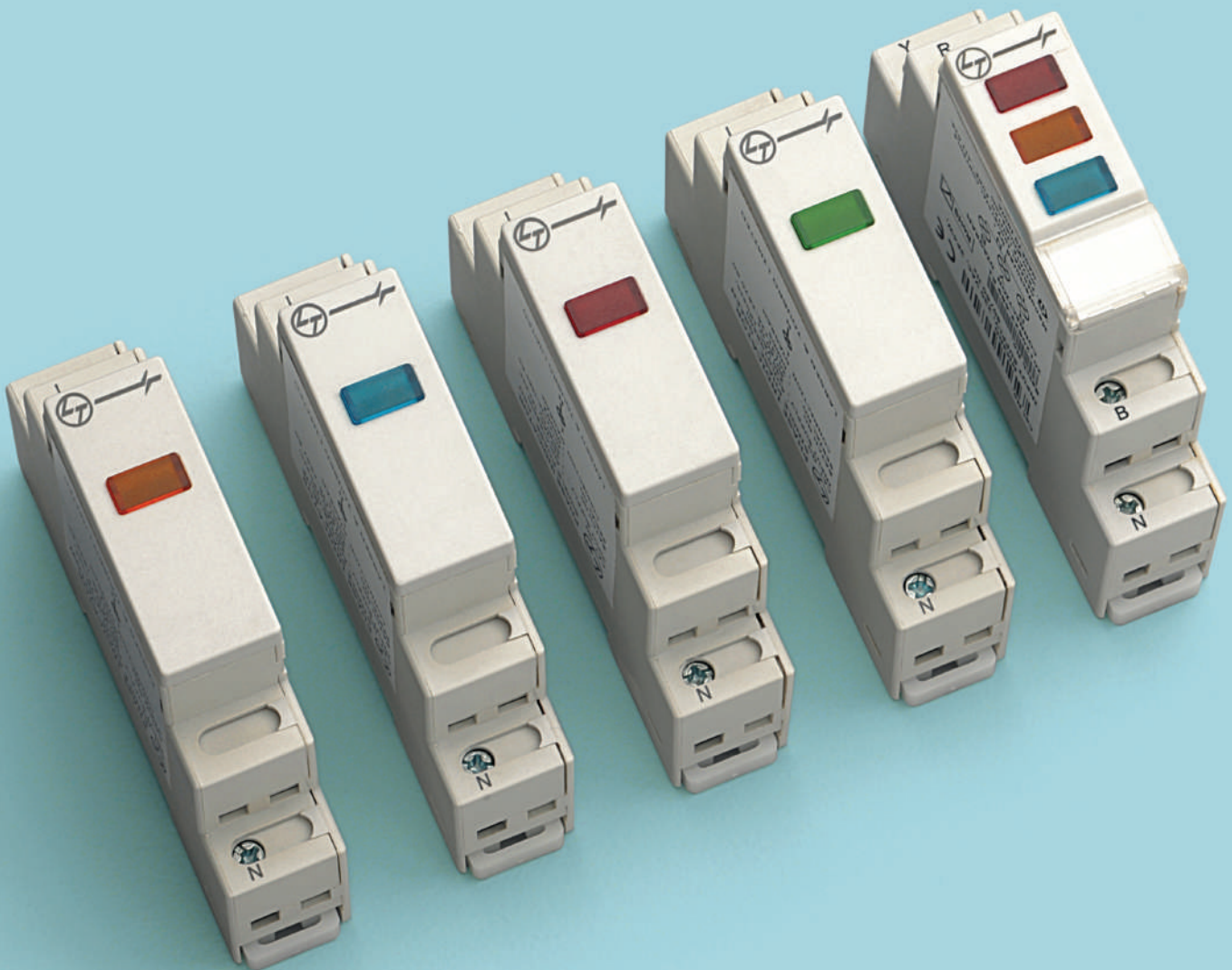



Convenient and efficient

- LED technology
- Modular design, suitable for DIN rail mounting
- Available in RED, YELLOW, BLUE and GREEN
- Three-in-one Indication R-Y-B in One Module



Product Specifications

GENERAL	
Rated Operational Voltage	240V AC
Power Consumption	1.8W
Rated Frequency	50/60Hz
Operating Temperature	-10°C to +55°C
Ingress Protection	IP 20

Decoding Product CAT Nos.: AU-IL

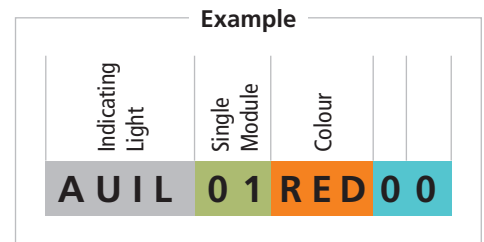
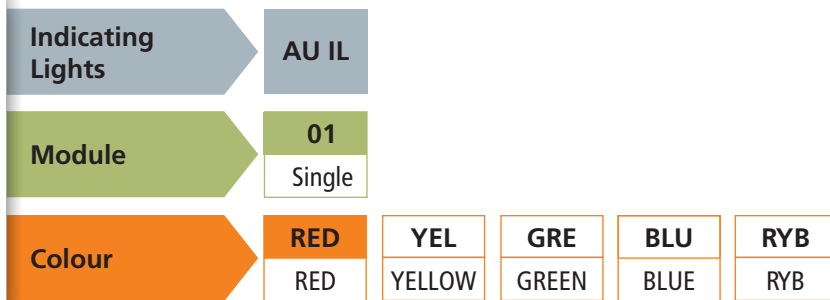

Product Range: AU-IL

Description	Modules	Cat. Nos.
 RED	1	AUIL 01RED00
YELLOW	1	AUIL 01YEL00
BLUE	1	AUIL 01BLU00
GREEN	1	AUIL 01GRE00
RED-YELLOW-BLUE	1	AUIL 01RYB00

Dimension Details – Indicating Lights

in mm

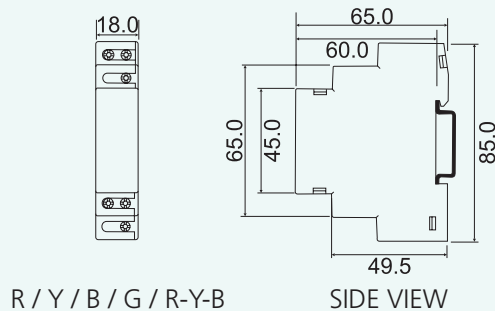



CONTROL DEVICES

The AU Solutions range includes a host of Control Devices.

Isolators

- 25A to 125A
- DP, TP and FP

Modular Contactors

- 25A to 63A
- SP, DP, TP and FP

Changeover Switches

- 25A to 63A
- DP and FP

Time Switches

- Digital
- Analog
- Astronomical

ACCL

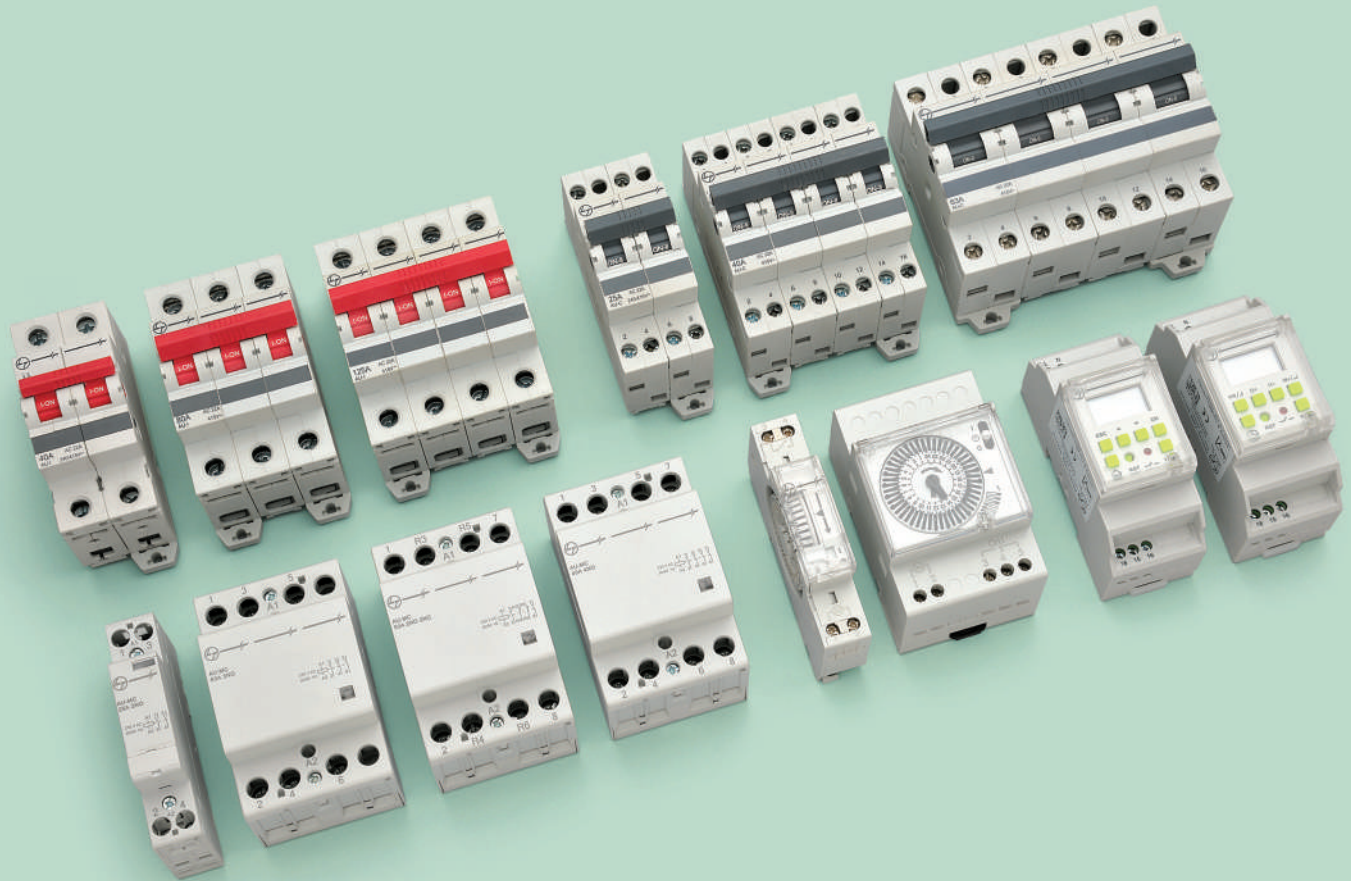

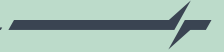

Isolators - Operational safety, downstream

Isolators are typically used for a switching function and to provide isolation in electrical circuits. The AU Solutions range of isolators is available from 25A to 125A in 2P, 3P and 4P versions.

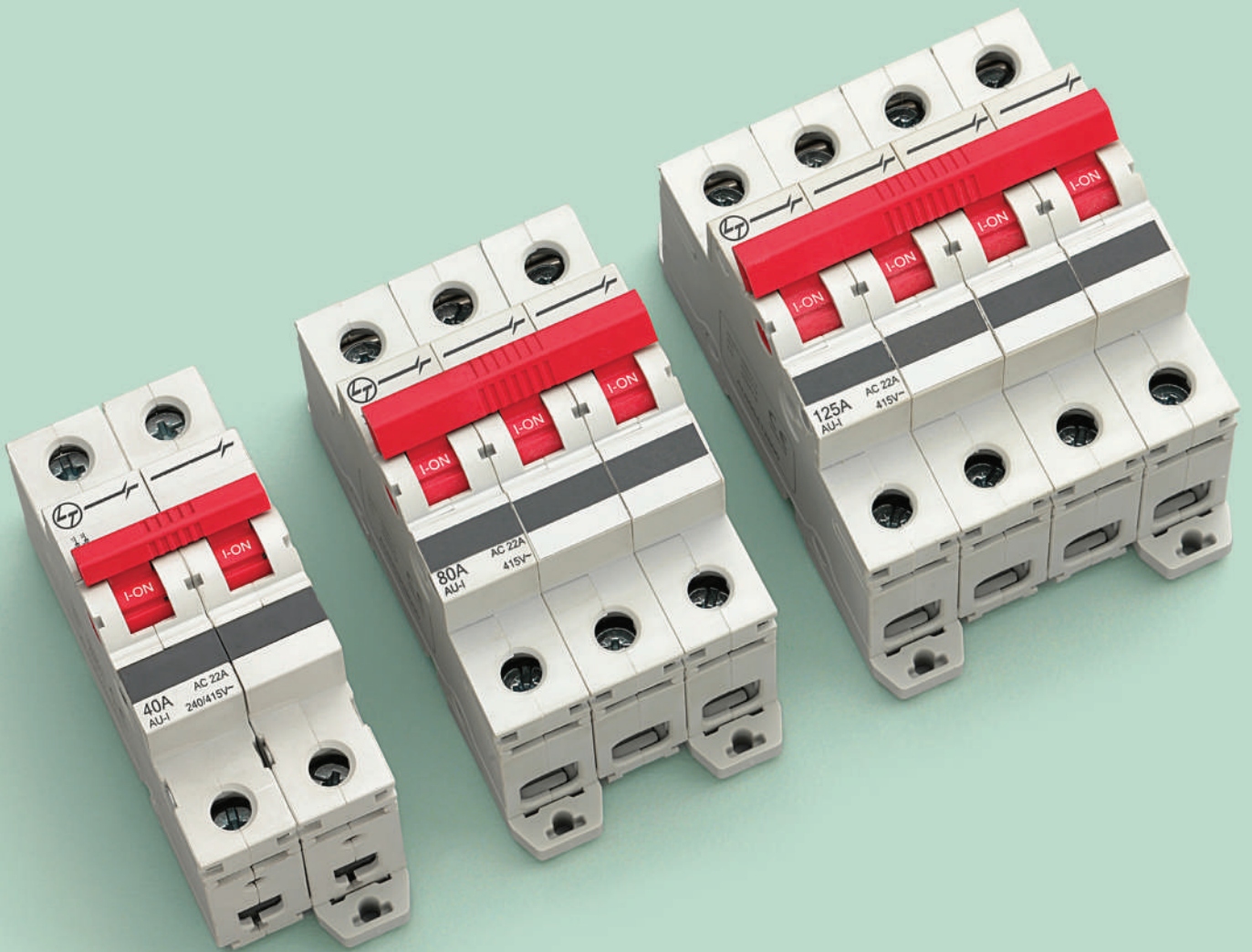



Optimum convenience, maximum safety

<p>Prevents Unauthorized Access</p>	<p>Ensures Safe Installation</p>	<p>Convenience</p>
<ul style="list-style-type: none"> • Provision for Padlock <ul style="list-style-type: none"> - Can be used either in ON or OFF position 	<ul style="list-style-type: none"> • Safety Shutter <ul style="list-style-type: none"> - Avoids incorrect cable insertion 	<ul style="list-style-type: none"> - Suitable for standard and cross-head (Phillips) screwdriver

Range Highlights

- Suitable for Isolation as per IEC 60947-3, IS/IEC 60947-3
 - providing operational safety downstream
- Comprehensive range – suitable for various applications
- Utilization Category of AC-22A
- Suitability for mounting Auxiliary Contacts

Product Specifications

ELECTRICAL	
Rated Operational Voltage	240/415V
Rated Frequency	50Hz/60Hz
Utilization Category	AC-22A
Rated Insulation Voltage,	500V
Rated Impulse withstand voltage	6kV
Short Time Withstand, Icw	20In for 1 sec
Short Circuit Making capacity, Icm	20In
Electrical Life (Operating Cycles)	20,000 up to 40A 15,000 63A 10,000 80A, 100A 2,500 125A

MECHANICAL	
Mechanical Life (Operating Cycles)	20,000

INSTALLATION	
Terminal Capacity	35 sq.mm (Rigid) } up to 63A 25 sq.mm (flexible) } 50 sq.mm (Rigid) } 80A to 125A 35 sq.mm (flexible) }

GENERAL	
Pollution Degree	3
Operating Temperature	-25°C to +60°C
Protection Degree	IP 20





Decoding Product CAT Nos.: AU-I

Isolator	AU I									
Number of Poles	2	3	4							
	2-Pole	3-Pole	4-Pole							
Rating (A)	025	032	040	050	063	080	100	125		
	25A	32A	40A	50A	63A	80A	100A	125A		

Isolator		Four Pole		125A		
A	U	I	00	4	125	00

Product Range: AU-I

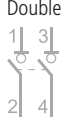

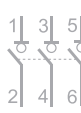
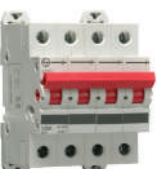
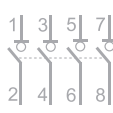
Description	Rating	Modules	Cat Nos
 Double Pole 	25A	2	AUI00 202500
	32A	2	AUI00 203200
	40A	2	AUI00 204000
	63A	2	AUI00 206300
	80A	2	AUI00 208000
	100A	2	AUI00 210000
 Three Pole 	125A	2	AUI00 212500
	32A	3	AUI00 303200
	40A	3	AUI00 304000
	63A	3	AUI00 306300
	80A	3	AUI00 308000
	100A	3	AUI00 310000
 Four Pole 	125A	3	AUI00 312500
	32A	4	AUI00 403200
	40A	4	AUI00 404000
	63A	4	AUI00 406300
	80A	4	AUI00 408000
	100A	4	AUI00 410000
	125A	4	AUI00 412500

Dimension Details – Isolators

in mm

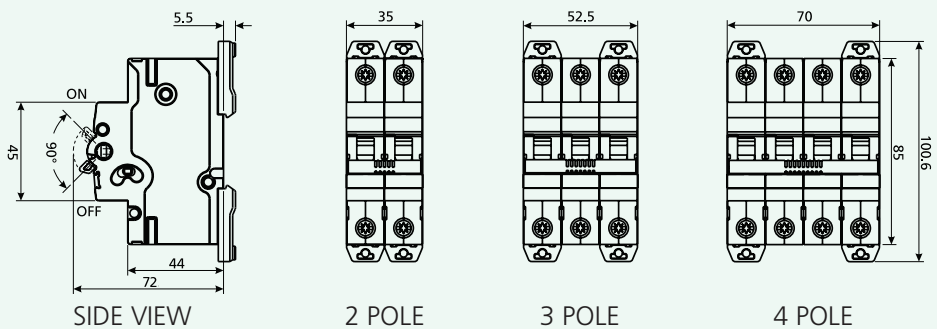



Changeover Switches - Change over to a secure power supply

If continuity of power is what you seek for your business, the AU Solutions range of manual Changeover Switches is the answer. The Changeover Switches perfectly suit your applications, having a range of up to 63A.

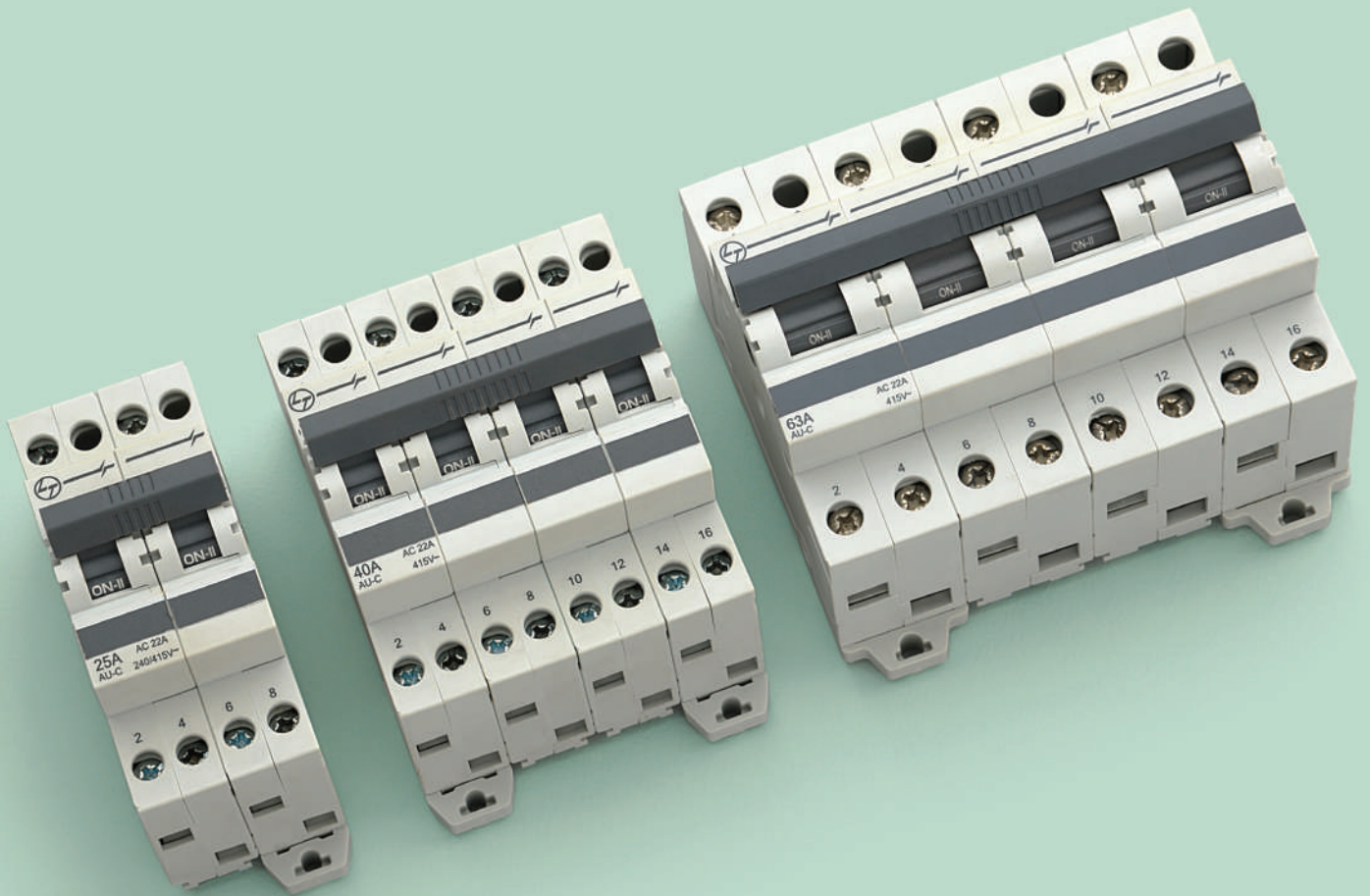

AU-C Range of Changeover Switches



Assured Safety

The AU Solutions range of Changeover Switches provides the perfect solution for low voltage distribution systems that need a continuous power supply. They have been developed and meticulously tested for a long life. The changeover switch range comprises 25A, 40A and 63A in 2P and 4P versions.



Prevents Unauthorized Access

- **Provision for Padlock**
 - Can be used either in ON 1 or ON 2 position

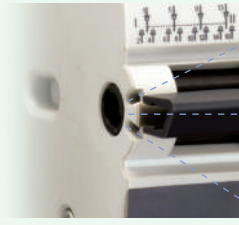

- **True Position Indication**
 - Knob indicates actual position of the contacts inside

Range Highlights

- Conforms to IEC 60947-3 and IS/IEC 60947-3
- Available in 3 positions (I-O-II) with centre off position
- Utilization category AC-22A

Product Specifications

ELECTRICAL	
Rated Operational Voltage	240/415V
Rated Frequency	50Hz/60Hz
Rated Insulation Voltage	690V
Rated Impulse Withstand Voltage	6kV
Rated Short-time Withstand Current	20In for 1 sec
Rated Short-circuit Making Capacity	1260A (Peak)
Electrical Life (Operating Cycles)	10,000

MECHANICAL	
Mechanical Life (Operating Cycles)	10,000

INSTALLATION							
Mounting Position	Horizontal / Vertical / Flat						
Terminal Capacity	<table style="border: none;"> <tr> <td style="border: none;">16 mm² (rigid)</td> <td rowspan="2" style="border: none;">} up to 40A</td> </tr> <tr> <td style="border: none;">10 mm² (flexible)</td> </tr> <tr> <td style="border: none;">25 mm² (rigid)</td> <td rowspan="2" style="border: none;">} for 63A</td> </tr> <tr> <td style="border: none;">16 mm² (flexible)</td> </tr> </table>	16 mm ² (rigid)	} up to 40A	10 mm ² (flexible)	25 mm ² (rigid)	} for 63A	16 mm ² (flexible)
16 mm ² (rigid)	} up to 40A						
10 mm ² (flexible)							
25 mm ² (rigid)	} for 63A						
16 mm ² (flexible)							

GENERAL	
Pollution Degree	3
Operating Temperature	-25°C to +60°C
Protection Degree	IP 20



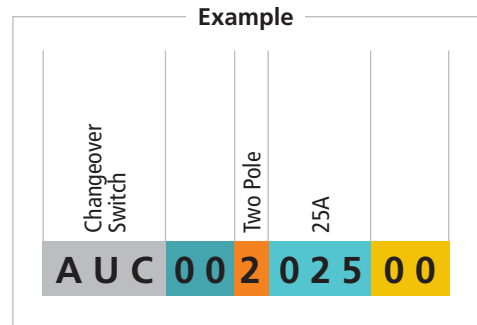

Decoding Product CAT Nos: AU-C

Changeover Switches	AU C		
Number of Poles	2	4	
	2 Pole	4 Pole	
Rating (A)	025	040	063
	25A	40A	63A



Product Range- AU-C

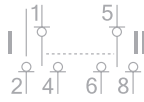

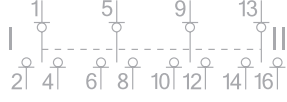
Description	Rating	Modules	Cat. Nos.
 <p>Double Pole</p> 	25A	2	AUC 00202500
	40A	2	AUC 00204000
	63A	3	AUC00206300
 <p>Four Pole</p> 	40A	4	AUC 00404000
	63A	6	AUC 00406300

Dimension Details – Changeover Switches

in mm

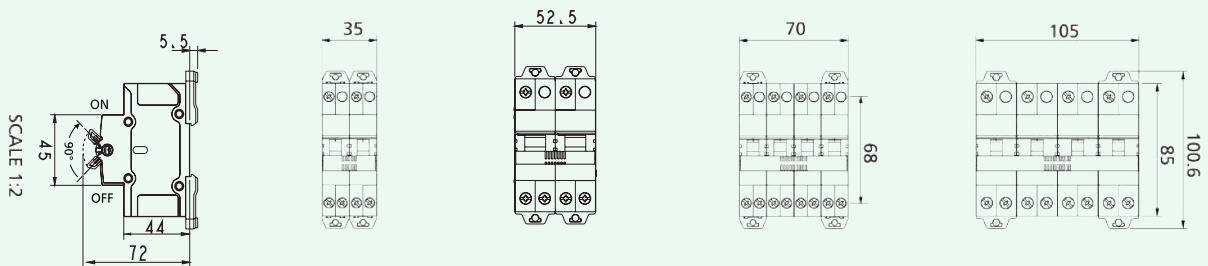

SIDE VIEW

2 POLE (25/40A)

2 POLE (63A)

4 POLE (40A)

4 POLE (63A)



Modular Contactors - The smart solution for remote switching

Modular contactors provide remote switching and automatic control of electric devices and equipment used in residential and commercial spaces.





Range Highlights

- Wide Range of Current Ratings:
 - 25A, 40A and 63A
- Conforms to:
 - IEC 61095, EN 61095
 - IEC 60497-4-1, EN 60497-4-1
 - IEC 60497-5-1
- Available in:
 - 1NO, 2NO, 3NO, 4NO
 - and 2NO+2NC version
- Protection Degree IP 20

Product Specifications

MAIN CIRCUIT		CONTROL CIRCUIT	
Rated Operational Voltage	230V/400V	Control Voltage (AC)	12V-230V
Rated Insulation Voltage	440V	Terminal Capacity	2.5 sq.mm
Rated Impulse withstand Voltage	4kV	Delay	15-25 ms
Rated Frequency	50Hz	Coil consumption	12VA & 10W
Electrical Life for -AC-1/AC-7a (Operating Cycles)	200000 (25A) 100000 (40A, 63A)	Frequency (AC)	50/60 Hz
Terminal Capacity	10 mm ² (rigid) } 25A 6 mm ² (flexible) } 25 mm ² (rigid) } 40A, 16 mm ² (flexible) } 63A		

Decoding Product CAT Nos.: AU-MC

Modular Contactors	AU MC					
	10	20	30	40	11	22
NO+NC	1NO	2NO	3NO	4NO	1NO+1NC	2NO+2NC
Rating (A)	025	40	63			
	25A	40A	63A			
No. of Modules	01	02	03			
	One	Two	Three			

Example

Modular Contactor	1NO	25A	One Module
AUMC	10	025	01

Product Range: AU-MC

Description (AC-1)	Modules	Cat. Nos.
25A-1NO 25A-2NO	1 1	AUMC1002501 AUMC2002501



Product Range: AU-MC

Description (AC-1)	Modules	Cat. Nos.
	40A-2NO	AUMC2004003
	40A-3NO	AUMC3004003
	40A-4NO	AUMC4004003
	63A-2NO+2NC	AUMC2206303
	63A-3NO	AUMC3006303
	63A-4NO	AUMC4006303
Auxiliary Contact, 2NO		AUMCAUX240

Dimension Details – Modular Contactors

in mm

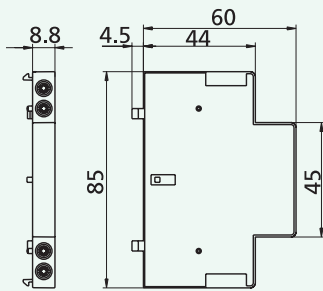

AUX CONTACT

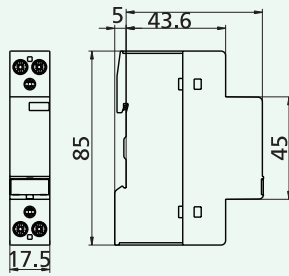

25A

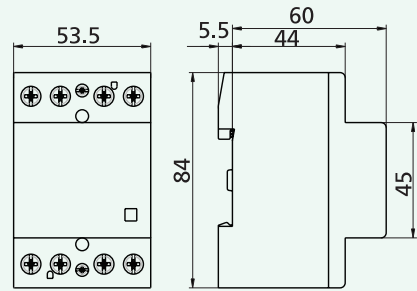

40A-63A

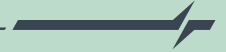

Time Switches - Ahead of their time

The AU Solutions range of Time Switches controls the ON and OFF operations of lighting and other loads. The range consists of Analog, Digital and Astro-time switches.



AU-TS Range of Time Switches



Reliability, simplicity and accuracy

Analog



- 1 Module (1 NO) and 3 Module (1 C/O)
- Power reserve of up to 150 hours
- Modular construction
- Inbuilt over-ride facility
- Minimum switching time: 30 min.

Digital



- Simple reset and manual override
- Keypad lock feature
- LED Indication for Relay Status
- 12/24-hour display format
- Weekend exclusion and weekly OFF programming
- 6-year battery reserve
- Minimum switching time: 1 min.
- 25 ON / OFF programmes

Astro



- Sunrise /sunset or twilight rise/set trigger modes
- Offset, OFF hours, weekly OFF feature
- 12/24-hour display format
- Easy manual override
- Ideal for outdoor and street lighting application
- Minimum switching time: 1 min.

Product Specifications

	Electrical		
	Analog	Digital	Astro
Rated Operational Voltage	230V AC/110V DC (1 Module)		110-240V AC
	230V AC/130V DC (3 Module)	-	-
Power Consumption	1 VA		6 VA
Resistive Load	16A/250V AC		16A (For NO) & 5A (For NC)
Inductive Load	4A/250V AC		6A/250V AC
Incandescent Lamp load	1000W (1 Module)		1000W
	1350W (3 Module)	-	-
Switching Time	30 min.		1 min.
LED indication	-		Red LED for relays status

	MECHANICAL		
	Analog	Digital	Astro
Output	1 NO (1 Module)		1 C/O
	1 C/O (3 Module)		-



	GENERAL		
	Analog	Digital	Astro
Accuracy	±1.5 sec/day at +20°C	±2 sec per day over the operating temp. range	
Operating Temperature	-20°C to +55°C	-10°C to +55°C	
Supply Failure Reserve	150 Hrs. rechargeable	6 years	
Manual Override	Yes		
Modes	ON, OFF*, AUTO	ON, OFF, Auto On, Auto Off, Auto	ON, OFF, AUTO
Protection Degree	IP 20		

* For 3 Module variant

Decoding Product Cat Nos.: AU-TS

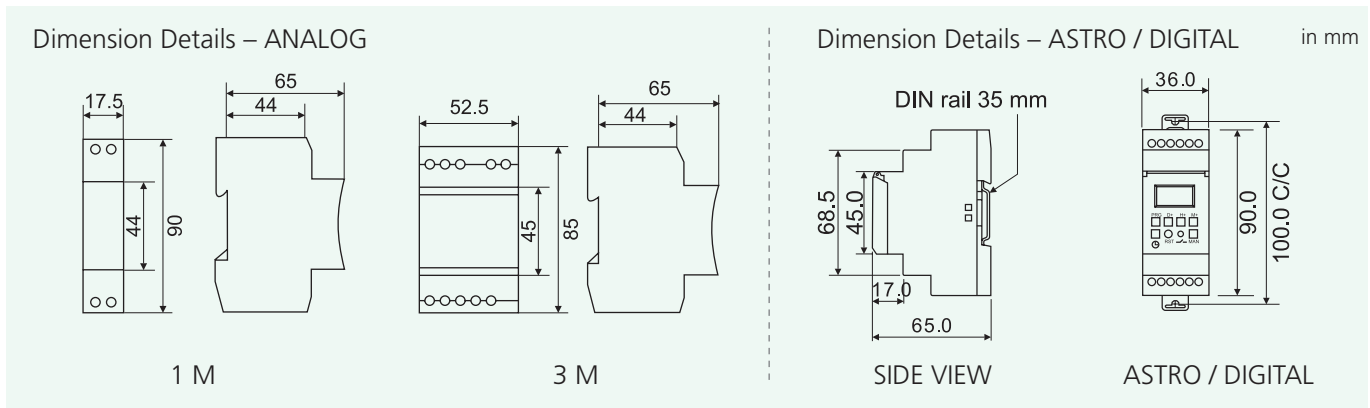
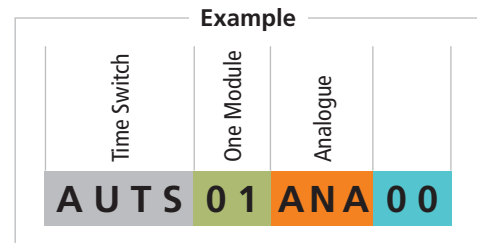
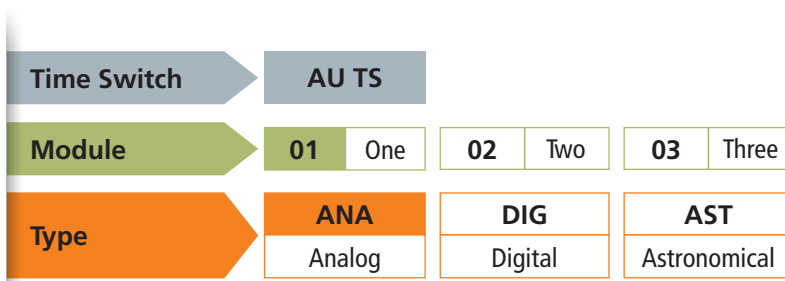

Product Range: AU-TS

Description	Modules	Cat. Nos.
Analog time switch	1	AUTS01ANA00
Analog time switch	3	AUTS03ANA00
Digital time switch	2	AUTS02DIG00
Astro time switch	2	AUTS02AST00

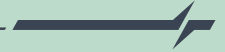

Controlling Devices - ACCL

Automatic Changeover with Current Limiter

A perfect solution for efficient distribution of generator power in high-rise apartments, townships, and commercial buildings. ACCL consists of three separate pair of terminals – two for connecting single phase supplies (main and back-up) and one for connecting single phase load. The ACCL will switch the load to back-up/generator supply when main/default supply goes off. On resumption of default supply, ACCL will automatically switch from back-up to default supply.





Intelligent and Reliable

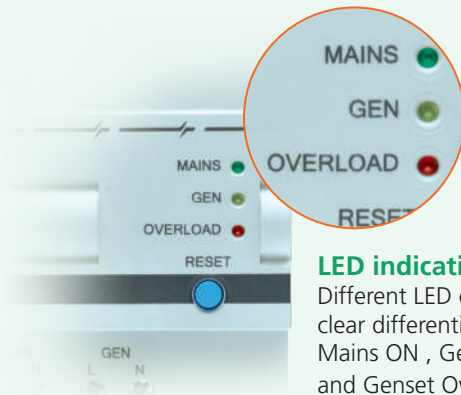

LED indication
Different LED colors for clear differentiation between Mains ON, Genset ON and Genset Overload



Reset Button
To Restore the supply to load, after non essential loads are switched off

Range Highlights

- Conforms to IEC 60947-6, IEC 60947-3
- Protection Degree - IP20
- Wide Range of Current Ratings
- Reliable microcontroller based design for sensing & control
- (Generator side) – 1.5A to 30A
- Lower power consumption
- (Electricity Boards side)- 30A
- RoHS compliant
- No. of Poles 1P+N

Product Specifications

ELECTRICAL		MECHANICAL	
Rated Operational Voltage	230V	Changeover time (Mains to DG)	~ 11 sec.
Rated Insulation Voltage	500V		
Rated Impulse Voltage	2.5kV		
Rated Frequency	50Hz		
Electrical Life (Operating Cycles)	6000		
Utilization Category	AC 31B (IEC 60947-6) / AC 21A (IEC 60947-3)		
Conditional short circuit current	3kA		
Dielectric strength	2kV		

INSTALLATION	
Terminal Capacity	6 mm ² (flexible) 10 mm ² (rigid)

GENERAL	
Operating Temperature	-5°C to 50°C

Decoding Product CAT Nos.: AU-CL

ACCL	AU CL
Phase	01 Single Phase
EB Rating (A)	030 30A
DG Rating (A)	<div style="background-color: #ffcc00; color: white; padding: 5px;">1E5 1.5A</div> <div style="background-color: #ffcc00; color: white; padding: 5px;">2E5 2.5A</div> <div style="background-color: #ffcc00; color: white; padding: 5px;">003 3A</div> <div style="background-color: #ffcc00; color: white; padding: 5px;">004 4A</div> <div style="background-color: #ffcc00; color: white; padding: 5px;">005 5A</div> <div style="background-color: #ffcc00; color: white; padding: 5px;">006 6A</div> <div style="background-color: #ffcc00; color: white; padding: 5px;">008 8A</div> <div style="background-color: #ffcc00; color: white; padding: 5px;">010 10A</div>

Example

ACCL	Single Phase	EB Rating- 30A	DG Rating 1.5A
AUCL	01	030	1E5



Product Range: AU-CL

Description	Single Phase ACCL	Modules	Cat. Nos.
	30A/1.5A	4	AUCL010301E5
	30A/2.5A	4	AUCL010302E5
	30A/3A	4	AUCL01030003
	30A/4A	4	AUCL01030004
	30A/5A	4	AUCL01030005
	30A/6A	4	AUCL01030006
	30A/8A	4	AUCL01030008
	30A/10A	4	AUCL01030010
	30A/12A	4	AUCL01030012
	30A/15A	4	AUCL01030015
	30A/20A	4	AUCL01030020
	30A/30A	4	AUCL01030030*

* Non-current limiting variant

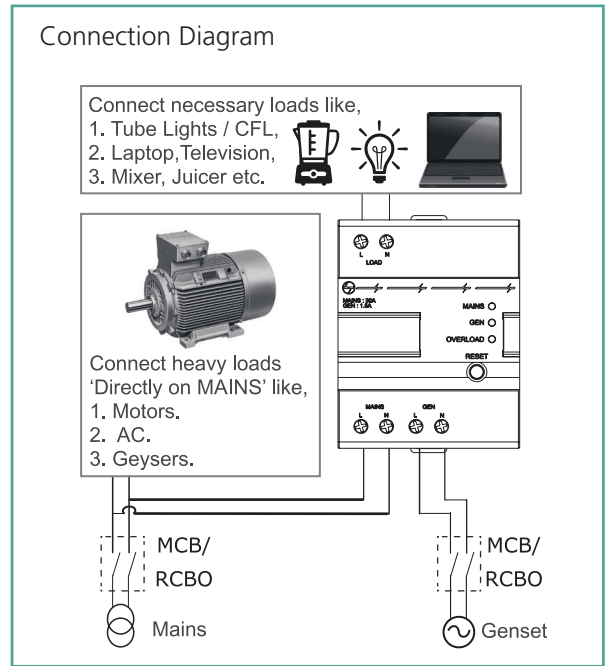
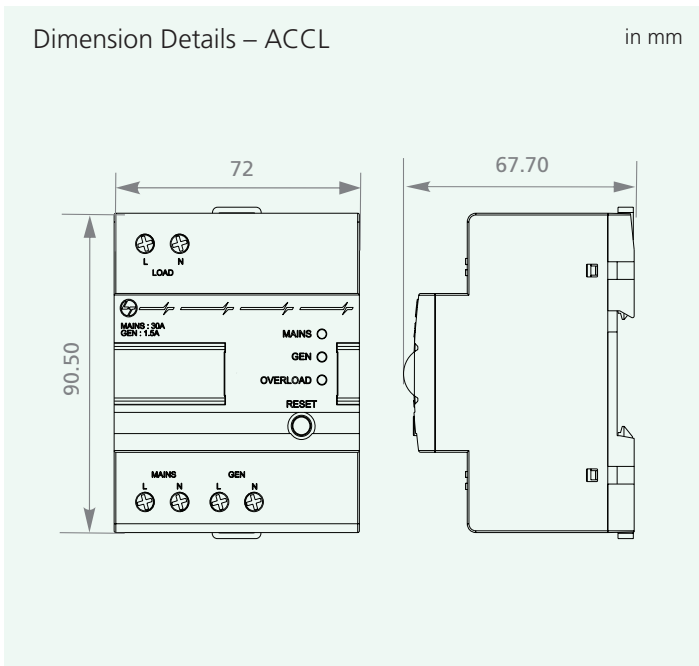

Recommended Backup MCB Ratings:

ACCL Ratings		MCB Ratings		ACCL Cat. Nos.
Mains	Genset	On Mains Side	On Genset Side	
30 A	1.5 A	32 A	2 A	AUCL010301E5
	2.5 A		3 A	AUCL010302E5
	3 A		3 A	AUCL01030003
	4 A		4 A	AUCL01030004
	5 A		5 A	AUCL01030005
	6 A		6 A	AUCL01030006
	8 A		10 A	AUCL01030008
	10 A		10 A	AUCL01030010
	12 A		16 A	AUCL01030012
	15 A		16 A	AUCL01030015
	20 A		20 A	AUCL01030020
	30 A		32 A	AUCL01030030

Timing Diagram:

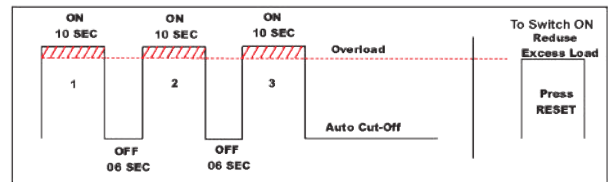



AU-COM - For Smart Systems

The AU Solutions range of final distribution products can be made communication-capable with AU-COM. The ease of use of the AU-COM user interface makes it a true, real-world solution.





Simplicity in communication

AU-COM addresses the remote monitoring and controlling requirement of the building and industrial segments. The communication solution consists of AU-COM & AU-CON (an optional Converter Module).

Range Highlights

- Can be deployed for AU range of MCBs, RCCBs, RCBOs and energy meters
- Capable of local and remote status monitoring of final distribution products- ON, OFF and TRIP
- With AU-COM and modular contactors AU-MC, remote controlling of the load can be achieved
- The convertor module converts RS 485 data signals from AU-COM into SCADA-compatible ethernet signals
- For remote monitoring and metering of energy, single-phase and three-phase energy meters with RS 485 converters or Wi-Fi modules can be used

Communication Solution

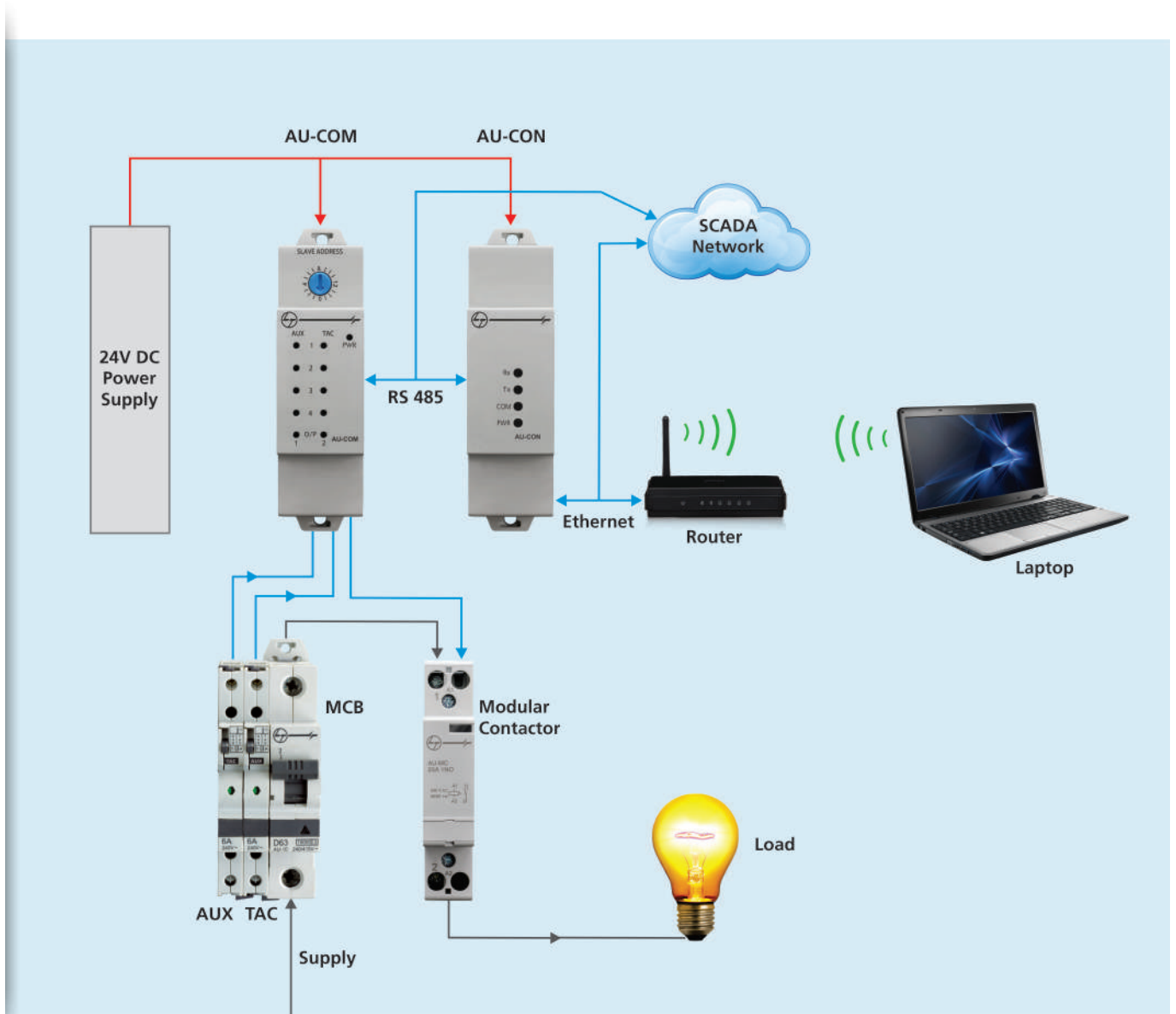



- In absence of control circuits, one can connect a maximum of 4 Auxiliary Contacts (AU-AUX) and 4 Trip Alarm Contacts (AU-TAC) with AU-COM
- With 2 control circuits in place, a maximum of 2 Auxiliary Contacts and 2 Trip Alarm Contacts can be deployed for status monitoring
- In all, 15 AU-COM modules can be connected in the system.

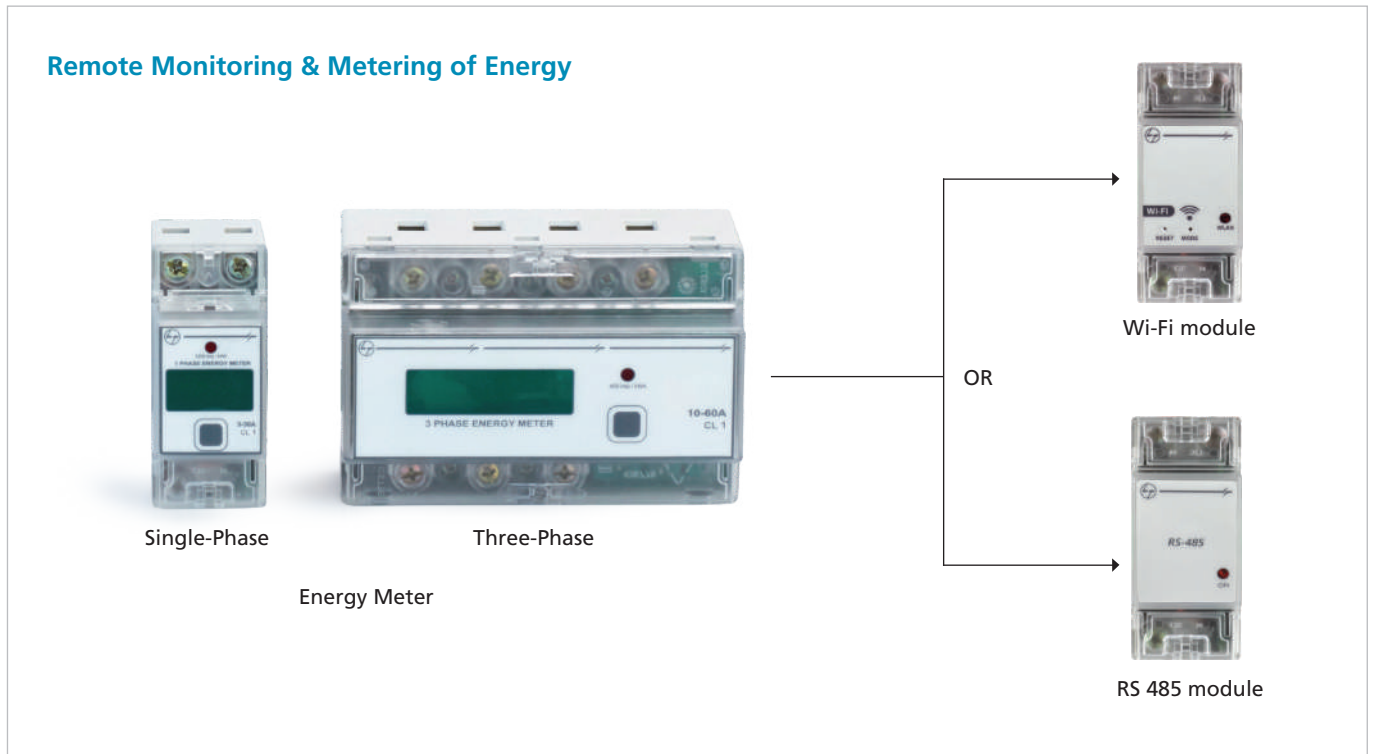

Product Specifications

Wi-Fi module	
Voltage rating	240 V (-30% to +20% AC)
Operating temperature	-10°C to 55°C
Power consumption	< 1W, 1VA in voltage circuits
Dimensions (H x W x D in mm)	83mm x 36mm x 66.5mm
Weight	115 g

For Single and three phase energy meter

RS 485 module	
Protocol	RS 485 RTU
Baud rate	1200, 2400, 4800, 9600, 19200
Parity	None, Odd, Even
Voltage rating	240 V (-30% to +20% AC)
Operating temperature	20°C to 70°C
Dimensions (H x W x D in mm)	83mm x 36mm x 66.5mm
Weight	115 g

For Single and three phase energy meter



AU-COM & AU-CON

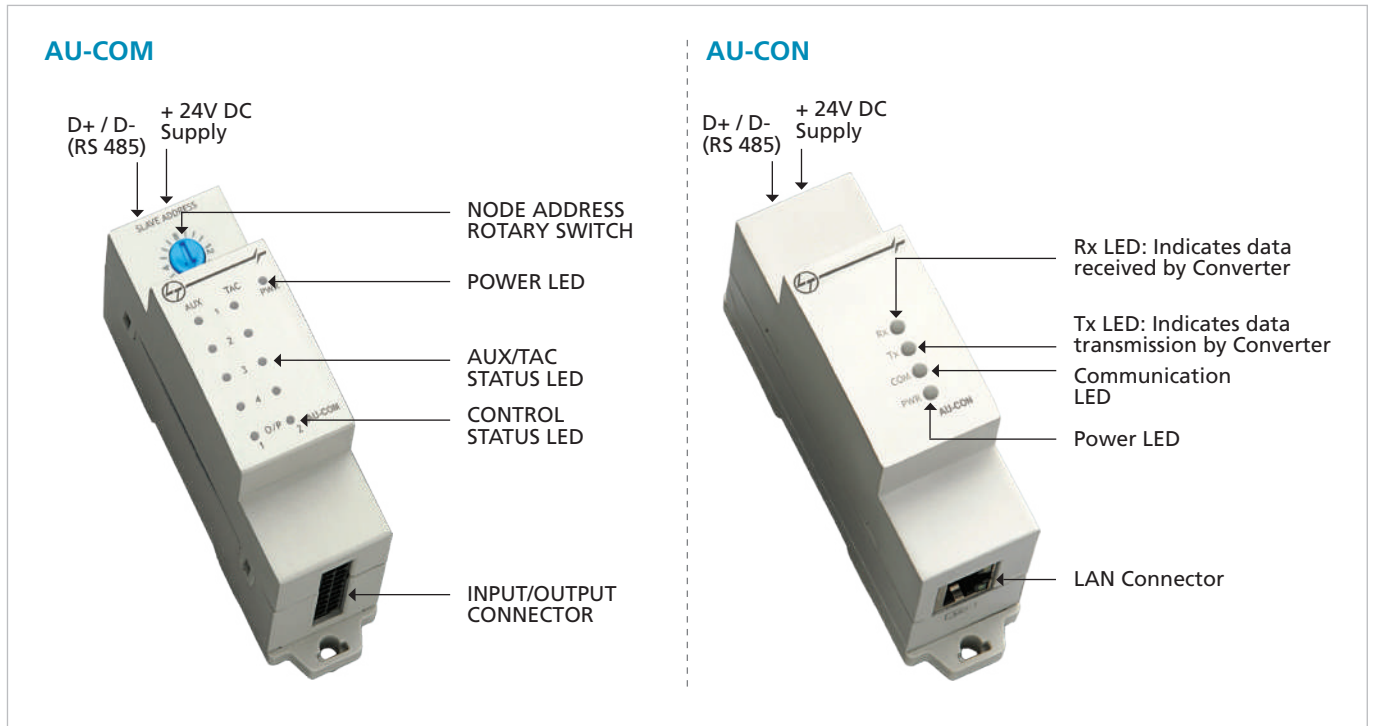

Product Specifications

AU-COM	
Conforms to	IEC 61131-2
Connection with HMI	Modbus-RTU (RTU Via TCP)
Breaker interface	4 Aux & 4 TAC
Output Control	2 Potential-free contacts for operation using relay (240VAC, 8A)
Power Supply	24V DC
Mounting	DIN Rail mountable
Dimensions (H x W x D in mm)	85mm x 26.3mm x 60mm

AU-CON	
Baud rate supported	1200, 2400, 4800, 9600, 19200, 8400, 57600, 115200
Ethernet	10/100Mbps
Power consumption	50mA at 24V DC, 2Watt max.
Dimensions (H x W x D in mm)	85mm x 26.3mm x 60mm

Modbus	
Node address	1-15 (using hexadecimal rotary switch)*
Baud rate	9600
Parity	None
Stop Bit	One

Ordering information

Description	Module	CAT Nos.
AU-COM communication module	1.5	AUCOM0402
AU-CON convertor module	1.5	AUCON0403
RS-485 module for single and three-phase energy meter	2	W1DLD0000RS
Wi-Fi module for single and three-phase energy meter	2	W1DLD0000WF

*Node Address '0' corresponds to default address of 1



Technical References

1. Understanding Final Distribution Level

Electricity is generated far from residential areas and complexes or load centers. It is transmitted from the points of generation to different load centers. The conventional methods for generation of electricity are hydro, thermal and nuclear.

Electric energy, obtained in the electric generation process, must be transmitted to the end-user by conductors of electricity without large resistive power losses in the distribution process. A key part in this process is the usage of transformers for increasing the voltage to hundreds of thousands of volts to minimize heating losses in the transmission lines.

The three high-voltage conductors on any utility pole indicate that the power distribution is on 'three-phase', with each conductor 120 degrees away from each other. At the load end of the circuit, the return paths of the three phase circuits can be coupled together at the neutral point.

In the case of end-users like street lights or residential consumers, only a single phase supply is needed. When distributing three-phase electric power, a fourth or neutral cable is run in distribution to provide a single phase circuit to each house. Different houses in the street are placed on different phases of the supply so that the load is balanced, or spread evenly, across three phases. Thus, the supply cable to each house would consist of a live and neutral conductor with possibly an earthed armoured sheath.

Major classes of loads generally used at the Final Distribution level are:

- Single-phase AC motors
- Incandescent Lamps
- Fluorescent Lamps
- Computer/UPS
- Other Electronic Loads

2. Types of Faults

There are various faults associated with distribution of electricity:

- a. Overcurrent fault
- b. Electric shock / leakage
- c. Undervoltage
- d. Overvoltage
- e. Surges

a. Overcurrent fault

In electricity supply, overcurrent or excess current is a situation in which an electric current larger than that intended passes through a conductor, leading to excessive generation of heat and the risk of fire or damage to equipment. Possible causes for overcurrent include short circuits, excessive load, and incorrect design. Fuses, circuit breakers, temperature sensors and current limiters are the commonly used protection mechanisms to control

the risks of overcurrent.

b. Electric Shock / Leakage

An electrical shock occurs when any part of a human body comes in contact with a source of electric current and it provides an unintended path and 'completes the circuit' between the electric source and ground. This electrical shock can simply cause a minor jolt, but it can also be fatal. A possible cause of an electric shock can be a puncture in the wire insulation.

c. Undervoltage

Undervoltage is defined as a condition where the applied voltage drops to 90% of the rated voltage, or less. Low-voltage conditions occur when a facility asks for more power than the line can deliver. In this situation, voltage drops somewhere between full power and a blackout. Common effects of such occurrences are noticeable, such as significant dimming of regular incandescent lights. The point to be noted here is it is not always an issue of the electric utility not having adequate capacity; transformers can act like a choke, restricting how much total power gets through to the system. Motors typically will end up drawing higher current in case of undervoltage situations, causing over-heating leading to subsequent destructions.

d. Overvoltage

Electronic and electrical devices are designed to operate at a certain maximum supply voltage, and considerable damage can be caused by a voltage that is higher than what the devices are rated for.

For example, an electric load (light bulb), at the given rated voltage, will carry current just large enough for the wire to get very hot but not hot enough for it to melt. The amount of current in a circuit depends on the voltage supplied. If the voltage is too high, then the wire may melt and the light bulb would have 'burned out'. Similarly, other electrical devices may stop working, or may even burst into flames if an overvoltage is delivered to the circuit.

e. Surges

Surges or transients are brief overvoltage spikes or disturbances on a power waveform that can damage, degrade, or destroy electronic equipment within any home, commercial building, industrial, or manufacturing facility. Transients can reach amplitudes of tens of thousands of volts. Surges are generally measured in microseconds.

Every piece of electrical equipment is designed to operate at a specified nominal voltage such as 120 V, 240 V, 480 V, and so on. Most of the equipment are designed to handle minor variations in their standard nominal operating voltage. However, surges can be very damaging to nearly all equipment.



3. Protection Devices

MCBs (Miniature Circuit Breakers)

Miniature Circuit Breakers are electromechanical devices that protect an electrical circuit from overcurrent. The overcurrent, in an electrical circuit, may result from short circuit, overload or faulty circuit design.

An MCB comes into operation in two main circumstances: First, due to the thermal effect of overcurrent (overload) and second, due to electromagnetic effect of overcurrent (short circuit). The thermal tripping of an MCB is achieved with a bimetallic strip. Whenever continuous overcurrent flows through MCB, the bimetallic strip is heated and deflects. This deflection of bimetallic strip releases mechanical latch. As this mechanical latch is attached with operating mechanism, it causes the MCB contacts to open. But during short-circuit, the sudden rise in electric current causes electromechanical displacement of plunger associated with tripping coil or solenoid of MCB. This plunger strikes the trip lever, causing immediate release of the latch mechanism, consequently opening the circuit breaker contacts.

In simple terms, an MCB is a switch that automatically turns off when the current flowing through it passes the maximum

allowable limit. It is a better alternative to a fuse, since it does not require replacement once an overload is detected. Unlike a fuse, an MCB can be easily reset, and thus offers improved operational safety and greater convenience without incurring high operating cost.

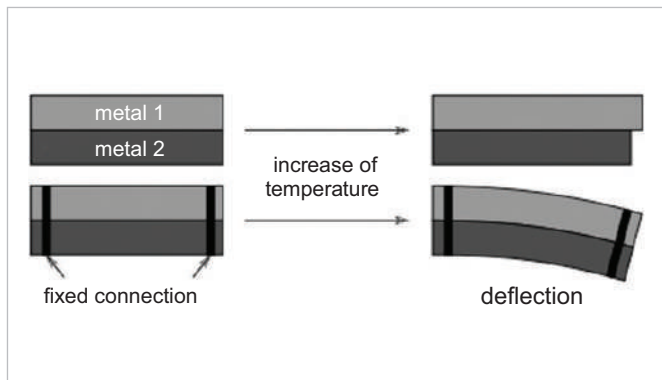
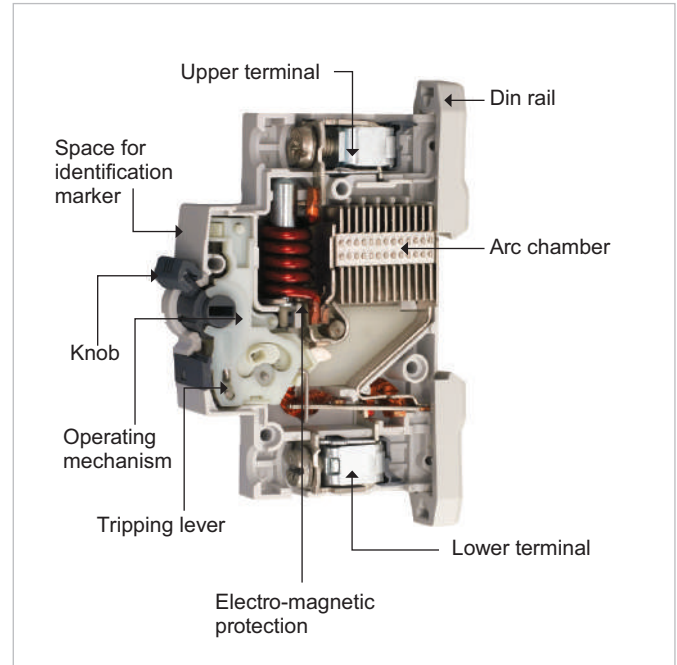

Bimetallic strip

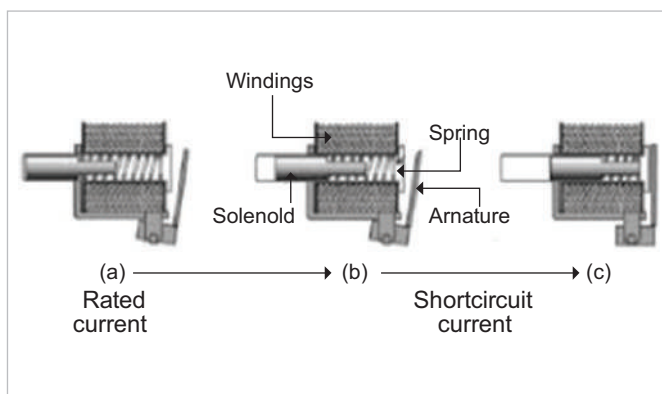

Solenoid

RCDs (Residual Current Devices)

It is a generic term which encompasses various forms of RCCBs and RCBOs. An RCD protects by constantly monitoring the current flowing in the live and neutral wires supplying to a circuit or an individual piece of equipment. Under normal circumstances, the current flowing in the two wires is equal. When an earth leakage occurs due to a fault in the circuit or an accident with the equipment, an imbalance occurs and this is detected by the RCD which automatically cuts off the power before any injury or damage takes place.

RCCB (Residual Current Circuit Breaker)

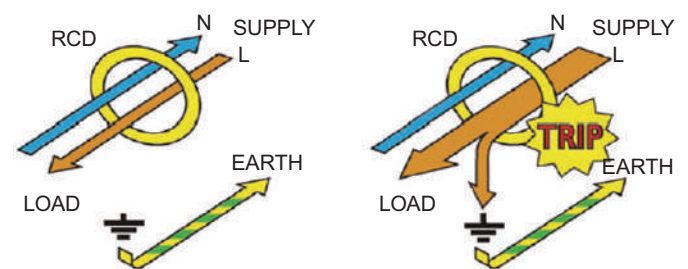

RCCBs are designed to give protection against earth leakages. These are not intended to provide protection against overload or short-circuit conditions.



RCBOs (Residual Current Circuit Breaker with Overcurrent Protection)

An RCBO is a mechanical switching device designed to make, carry and break currents under normal service conditions and cause the opening of the contacts when the residual current attains a given value under specified conditions. In addition, it is designed to give protection against overloads and short-circuits. It is a combination of RCCB and MCB which provides 3-in-1 protection against earth leakages and over-currents due to short circuit and over-loading.

SPDs (Surge Protection Devices)

SPDs are devices that shield electromechanical / electrical / electronic circuits or equipment from a sudden and destructive increase (surge) in the line voltage caused usually by direct lightning strikes, indirect lightning strikes, or due to faults of in-house operational devices. It does this by momentarily 'switching' from an open-circuit / high-resistance mode into a low-impedance mode sensing the overvoltage. This low impedance mode diverts the surge current through it and in doing so, limits the overvoltage to a safe level. When the surge event is over, the protector returns to its open circuit mode.

Surge Protection Device Analogy with Water flow

Surge protection method can be best understood by water flow analogy. To control the flow of water, it needs to be stopped/regulated at different locations so that only the required volume of water flows to the receiving end and is productively utilized, Similarly, to control the electrical surges in the system in permissible limit, the excess current which is generated due to a surge needs to be removed from the system. This is achieved by a Surge Protection Device (SPD).

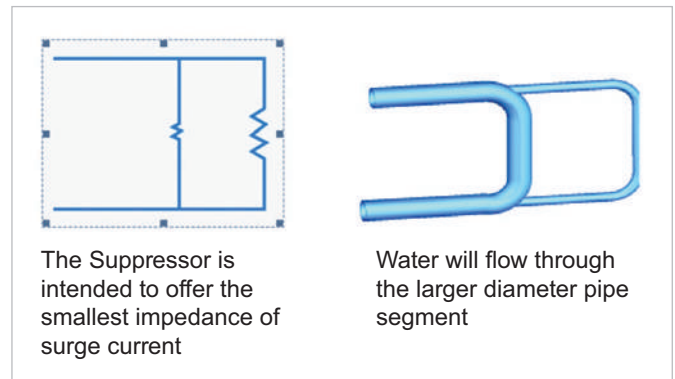

- **Nominal/Operating Voltage (Un):** The nominal voltage stated for a SPD corresponds to the system voltage of the typical SPD installation site, e.g., 230/400 V AC.
- **Maximum continuous voltage (Uc):** Maximum r.m.s. voltage that can be applied continuously to the terminals of the SPD.
- **Temporary overvoltage (UT):** TOV is the maximum r.m.s. voltage that the SPD can withstand for 5 seconds, without failure.
- **Voltage protection level (Up):** Maximum voltage that can occur on the connection terminal blocks of the SPD. In the event of a surge voltage or surge current within the performance parameters of the SPD, the voltage is safely limited to a maximum of this value at the protected connections of the SPD.
- **Nominal Discharge Current (In):** The nominal discharge current (In) is the level of impulse current a surge protector can withstand repeatedly (15 surges) without destruction
- **Impulse current (Iimp):** Maximum impulse 10/350 μ s current a surge protector can withstand without destruction. The pulse shape (10/350 μ s) of a surge current is used for simulating the current flow of direct lightning strikes.
- **Maximum discharge current (Imax):** Maximum impulse 8/20 μ s current a surge protector can withstand without destruction. The pulse shape (8/20 μ s) of a surge current is characteristic of the effects of an indirect lightning strike or switching operation.

MCB for backup protection of SPD

SPD	MCB rating & Curve
AUSP121PN50	125A - C curve
AUSP123PN50	125A - C curve
AUSP021PN40	50 A - C curve
AUSP023PN40	50 A - C curve
AUSP021PN15	20 A - C curve
AUSP023PN15	20 A - C curve
AUSP121PN100	100 A - C curve
AUSP123PN100	100 A - C curve
AUSP021PN70	100 A - C curve
AUSP023PN70	100 A - C curve

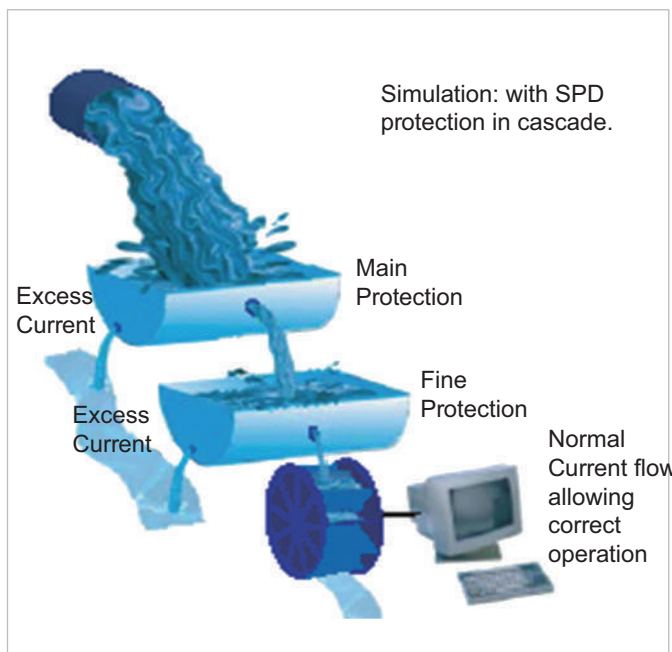



4. Selection Of MCBs

An MCB is an automatically-operated electrical switching device, designed to protect an electrical circuit from damage due to overcurrents. Its basic function is to detect a fault condition, interrupt continuity and to immediately discontinue flow of current. Unlike a fuse, which operates once and then has to be replaced, a circuit breaker can be reset (manually) to resume normal operation.

Over-currents are chiefly due to two reasons:

a. Short-circuit

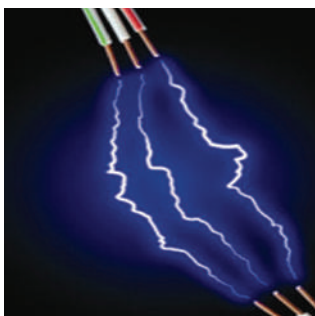

b. Overload



The inverse time delay characteristics as per MCBs, complying with IEC 60898, must operate within the limits specified below:

I_n = rated current

a. Overload (Thermal characteristics)

Fault Current	Trip Time
1.13 I_n	Greater than 1 hour
1.45 I_n	Less than 1 hour
2.55 I_n	1 to 120 seconds

b. Short-circuit (Magnetic characteristics)

Curve Type	Breaker Trip limits
Type B	3 to 5 times I_n
Type C	5 to 10 times I_n
Type D	10 to 20 times I_n

Selection of an MCB depends mainly on the following three parameters:

- i. Current Rating of the MCB
- ii. Characteristic Curve as per the application
- iii. Short-circuit breaking capacity in line with fault level

i. Selecting current rating of an MCB

In order to achieve perfect overload protection, the rated current (I_n) of an MCB should not be less than the design current or rated current (I_c) of the circuit and that (I_n) should not exceed the current carrying capacity of the conductor or wire (I_w).

$$I_c < I_n < I_w$$

As per the thermal characteristics table the (I_w) should be a minimum of 1.45 times (I_n).

For Example:- For a load of 1200 W, 240V supply, the load current is 5 A

$$P = V I \text{ (resistive load)}$$

Where P = power in Watt, V = Voltage in Volts and I = Current in Ampere

Hence, the rating of an MCB to be selected should be equal to or greater than 5 A and the nearest MCB rating available is 6A.

And the minimum trip current for the MCB is $6A \times 1.45 = 8.7 A$

Accordingly, the wire size should be selected with a current carrying capacity of more than 8.7 A

So, the nearest wire size available with current carrying capacity of more than 8.7 A is 11 A (i.e 1 sq mm) - as per IS:3961)

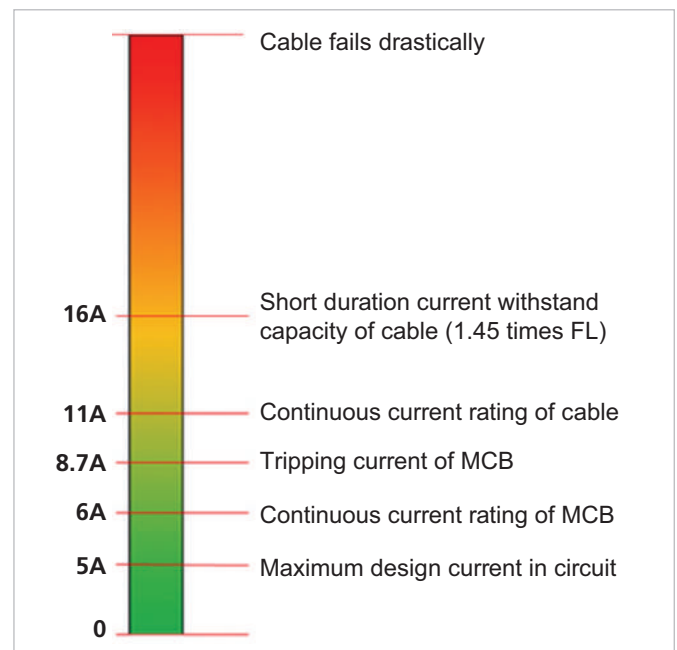



ii. Selecting Characteristic curve of an MCB

Type	Setting	Application
B	3-5 In	Generators-sensitive loads very long circuit runs Examples : Incandescent lights, heater, geyser
C	5-10 In	General, light and power Example : Fluorescent lights, small motors, fans, refrigerators, window/split ACs
D	10-20 In	Transformers sodium lighting highly inductive loads Examples : Water lifting pumps, UPS

Typical Characteristic Curves of an MCB are as shown below:

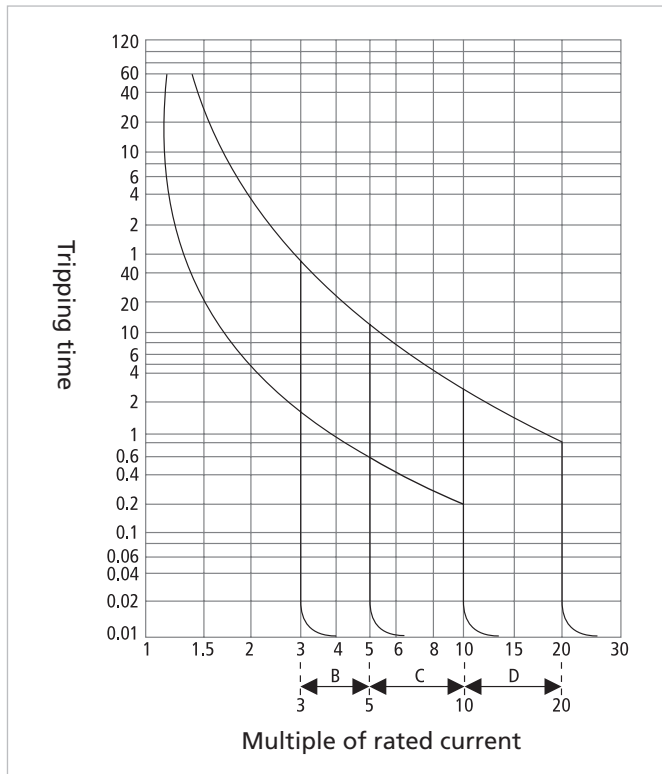

General B, C and D curve Characteristics

MCBs are typically offered in B, C and D characteristics. For an application involving purely resistive loads such as incandescent lights and heaters, MCBs with characteristic B are used. If the load is split ACs or refrigerators, B-curve MCBs might offer nuisance tripping due to high level of initial currents. In such conditions, one needs to choose C-curve MCBs. Further, there can be applications such as UPS where even C-curve MCBs might offer nuisance tripping due to very high level of inrush currents. In such scenarios, D-curve MCBs are best suited. Therefore, it is advisable to select appropriate MCBs as per the requirements of the specific application.

iii. Selecting short circuit breaking capacity of an MCB

The third selection parameter is the short circuit breaking capacity, which is required to protect against heavy current, which maybe

in thousands of amps is caused by a short-circuit. The ability of an MCB to protect from this fault is defined by its short-circuit rating.

The fault level depends primarily on:

- 1. Transformer rating:** Fault level is directly proportional to the transformer rating.
- 2. Fault impedance:** If the distance of fault from the source (transformer in this case) is less, the fault impedance is less and thus the fault level is high and vice versa.

5. Selection of RCDs

RCD is a general term for Residual Current Devices.

RCCB: Residual Current Circuit Breaker

RCBO: Residual Current Circuit Breaker with Over current Protection

Selection between RCCB and RCBO

Depending upon the requirement of overcurrent protection, one can choose between the RCCB and RCBO. If only residual current protection is required, then an RCCB should be considered.

How to select an RCCB/RCBO?

Selection of RCCB/RCBO is dependent on the following parameters:

- Types of RCD
- Rated residual tripping current
- Operating time

Selecting Type of RCD

- Types of RCD

RCDs are classified into the categories listed below in accordance with their ability to ensure protection against various types of residual currents:

Type	Description	Application
AC	For - pure AC current	Electrical devices (non-electronics)
A	For - pure AC current - pulsating DC	Electrical devices (electronics and non-electronics)
B & F	For - pure AC current - pulsating DC - smooth DC	Electrical drives Frequency inverters Computed tomography
Adi	For - pure AC current - pulsating DC - harmonics and transients	IT parks Data centers

ii. Rated residual tripping current

RCDs can be provided with varieties of rated residual operating current. Its range could vary from 10mA to 500mA.



30mA is the maximum value permissible for personal shock protection and 300mA is the maximum value permissible for fire protection. Non-standard values may be used, but the shock and fire limits must not be exceeded.

RCDs can be used where it is necessary to protect a circuit or an installation against dangerous residual currents. The three main areas for such protection are as follows:

- a. Protection against fire.
- b. Fault protection (protection against indirect contact)
- c. Basic protection (protection against direct contact)

Sensitivity	Typical Applications
10mA	Human protection-wet areas, swimming pools, jacuzzis
30mA	Human protection-kitchens, bathrooms, laboratories, schools & workshops
100mA	Installations where there is inherent seepage / with limited personal protection
300mA	Cable / fire protection
500mA	Special purpose machines

iii. Operating time

RCDs fall into two categories in terms of the time taken to respond to and clear residual currents, as follows:

a. General Type: These RCDs have no specified minimum response time but have specified maximum response time

$$I_{\Delta N} : T < 300\text{ms}$$

$$5 I_{\Delta N} : T < 40\text{ms}$$

b. S Type: These RCDs, commonly known as delayed types, have specified minimum and maximum response time, as follows:

$$I_{\Delta N} : 130 - 500\text{ms}$$

$$5 I_{\Delta N} : 50 - 150\text{ms}$$

Delayed response (S Type) RCDs are commonly fitted upstream of general type RCDs, but general type RCDs should never be fitted upstream of delayed types.

The term 'upstream' refers to proximity to the origin of the installation and 'downstream' refers to proximity to the load.

6. Selection of SPDs

Selection of SPD depends on following parameters:

- i. Type of equipment to be protected
- ii. According to different types of standards

i. Type of equipment to be protected

All the electrical and electronic devices have some impulse voltage withstand capacity. So, it is required to keep impulse voltage within this limit. These high voltages are generated because of lightning surges of voltage transients. Typical impulse withstands capacity for various equipment is as below:

Category	I	II	III	IV
impulse voltage withstand (kV)	1.5	2.5	4	8
Type of equipment	Electronic devices	Electrical appliances (refrigerators, oven, etc.)	Distribution and final circuits (motors, sockets, etc.)	Incomer, meter

ii. According to different types of standards

As per international standards, SPDs are classified as lightning current arresters (Class I), surge protection devices (Class II) or device protection (Class III). Each class is defined by performance testing methods for surge current handling capability.

Type 1 / Class I SPDs (lightning arresters) are mainly installed in the electrical entry panel or the Main Distribution Panel. This is the first stage protection in the electrical network, and the surge arrester is designed to divert lightning energy caused by an overvoltage comparable to that of a direct lightning strike to the power lines or equipment. These protectors must be designed to survive the 10/350 μs waveform. In addition, Class I lightning arresters are tested with 8/20 μs current impulses for nominal discharge current ratings. These SPDs are called Type 1+2 SPDs.

It must be understood that Class I SPDs are only for insulation breakdown protection; e.g. protecting the wires, insulation/dielectrics, and other components of the electrical distribution system. These SPDs are not intended to prevent damage to electronics and sensitive equipment. Most SPD manufacturers use discharge gap technology to meet the challenging test requirements of surviving multiple 10/350 μs wave shape hits without damage or degradation. The discharge gap handles high surge currents of 100kA and does not suffer from leakage current when not conducting. Typically, Type 1 SPDs provide impulse withstand voltage level of 1.5 - 2 kV.

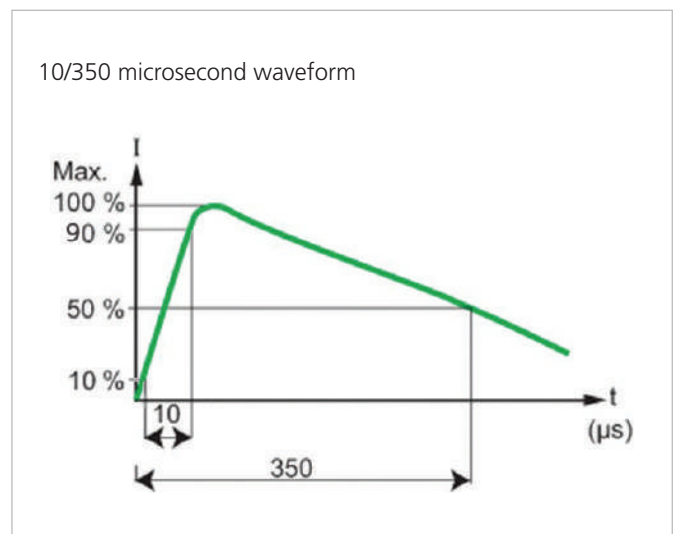

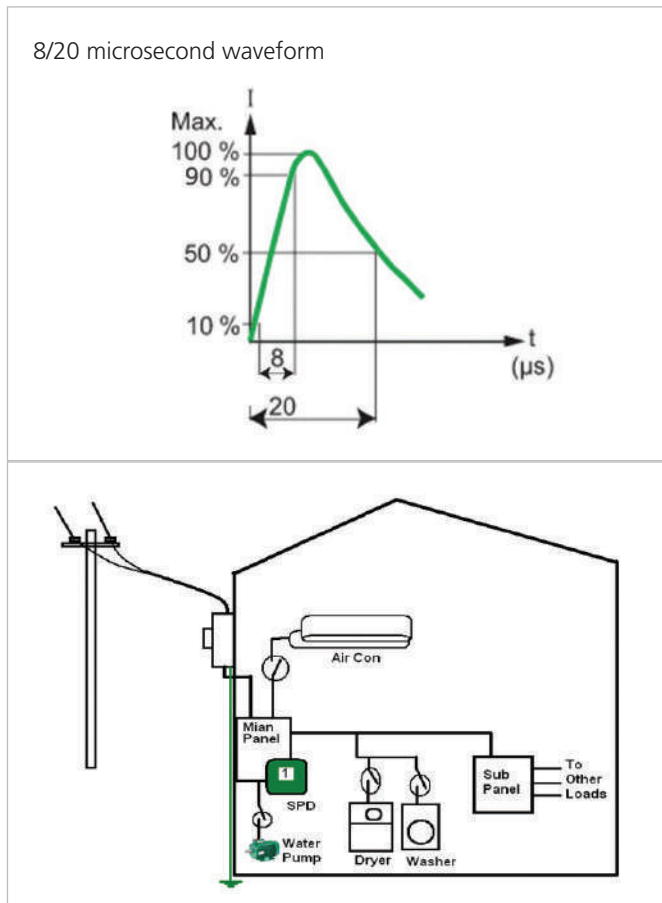

Coordination Stage	Stage 1	Stage 2	Stage 3
Surge Threat	Lightning	Lightning & Inductive	Inductive
IEC 61643-1	Class I test (10/350 μs)	Class II test (8/20 μs)	Class III test (8/20 μs)
EN/IEC 61643-11	Type 1 : (10/350 μs)	Type 2 : (8/20 μs)	Type 3 : (8/20 μs)
IEC Test Waveform	10/350 μs	8/20 μs	1.2/50 μs + 8/20 μs
IEEE C62.41	Location C (10/350 μs)	Location B (8/20 μs)	Location A (8/20 μs)
UL 1449	Type 1 (10/350 μs)	Type 2 (8/20 μs)	Type 3 (8/20 μs)
IEEE Test Waveform	10/350 μs	8/20 μs	1.2/50 μs + 8/20 μs

7. General Terminologies (Reference IEC 60947-1)

a. Degree of Pollution

Pollution degree of environmental conditions is a classification based on the amount of conductive dust, ionized gas or salt and on the relative humidity and its frequency of occurrence resulting in condensation of moisture leading to reduction of dielectric strength. In short, 'Pollution Degree' refers to the environmental conditions for which the equipment is intended.

As per IEC, the four degrees of pollution are defined as follows:

Pollution Degree 1:

No pollution or only dry, non-conductive pollution occurs.

Pollution Degree 2:

Normally, only non-conductive pollution occurs. Occasionally, however, temporary conductivity caused by condensation may be expected.

Pollution Degree 3:

Conductive pollution occurs, or dry, non-conductive pollution occurs which becomes conductive due to condensation.

Pollution Degree 4:

The pollution generates persistent conductivity caused, for instance, by conductive dust or by rain or snow.

Below are a few examples of such environments.

Pollution Degree 1	Pollution Degree 2	Pollution Degree 3	Pollution Degree 4
Clean Rooms	Laboratories	Industrial Area	Electrical Equipment for outdoor use
	Test Stations	Boiler Rooms	
	Office Environment		

Type 2 / Class II SPDs are mainly installed in secondary distribution panels as the second stage of protection. The Class II SPD along with the first stage Class I arrester provides a better level of protection to equipment. These SPDs offer a lower surge capacity and provide a lower clamp level than the primary suppressor. These SPDs also suppress any surge currents generated by induced lightning currents / partial lightning and operational switching action in the electrical network. These SPDs are tested with 8/20μs surge currents, and typically offer a voltage protection level of around 1.5-1.2 kV. It is important to note that this voltage level can still potentially allow damage to sensitive equipment.

Type 3 / Class III SPDs must be installed as a supplement to Type 2 SPDs and can be located in the immediate vicinity of sensitive loads. Critical applications with sensitive equipment include medical imaging, cloud servers, and video surveillance. The function of a Class 3 device is protection of sensitive electronic equipment and thus the voltage protection level should be < 600 V. These devices are tested similar to the Class II SPDs (1.2/50 μs and 8/20 μs waveforms) but have lower discharge current capability. Many times, Type 2 products are declared as Type 3 and, it is, therefore, important to check that these SPDs offer voltage levels of ≤ 600 V.



As per IEC, the products intended for a particular ‘Pollution Degree’ will have to follow the guidelines for clearance and creepage distances. Clearance is the distance between two conductive parts, along a string stretched at shortest way between these conductive parts. Creepage distance refers to the shortest distance along the surface of an insulation material between two conductive parts. Typically, the equipment for industrial applications are generally for use in pollution degree 3 environments.

b. Mechanical Impact Protection Index – IK

It is the degree of protection provided by distribution boards and enclosures for electrical equipment against external mechanical impacts as provided in the international standard IEC 62262. It provides a means of specifying the capacity of an enclosure to protect inside devices from external impacts.

IK	IMPACT ENERGY (J)	EQUIVALENT IMPACT
00	Unprotected	No Test
01	0.14	Drop of 250g object from 5.6cm height
02	0.2	Drop of 200g object from 10cm height
03	0.35	Drop of 250g object from 14cm height
04	0.5	Drop of 200g object from 25cm height
05	0.7	Drop of 250g object from 28cm height
06	1	Drop of 250g object from 40cm height
07	2	Drop of 500g object from 40cm height
08	5	Drop of 1.7kg object from 30cm height
09	10	Drop of 5kg object from 20cm height
10	20	Drop of 5kg object from 40cm height

c. Degree of Protection – IP

As per IEC standard, Ingress Protection level IPXX is defined with two numerals. The first numeral defines protection against ingress of solid objects while the second numeral defines protection against harmful ingress of water.

Classification of IP Levels

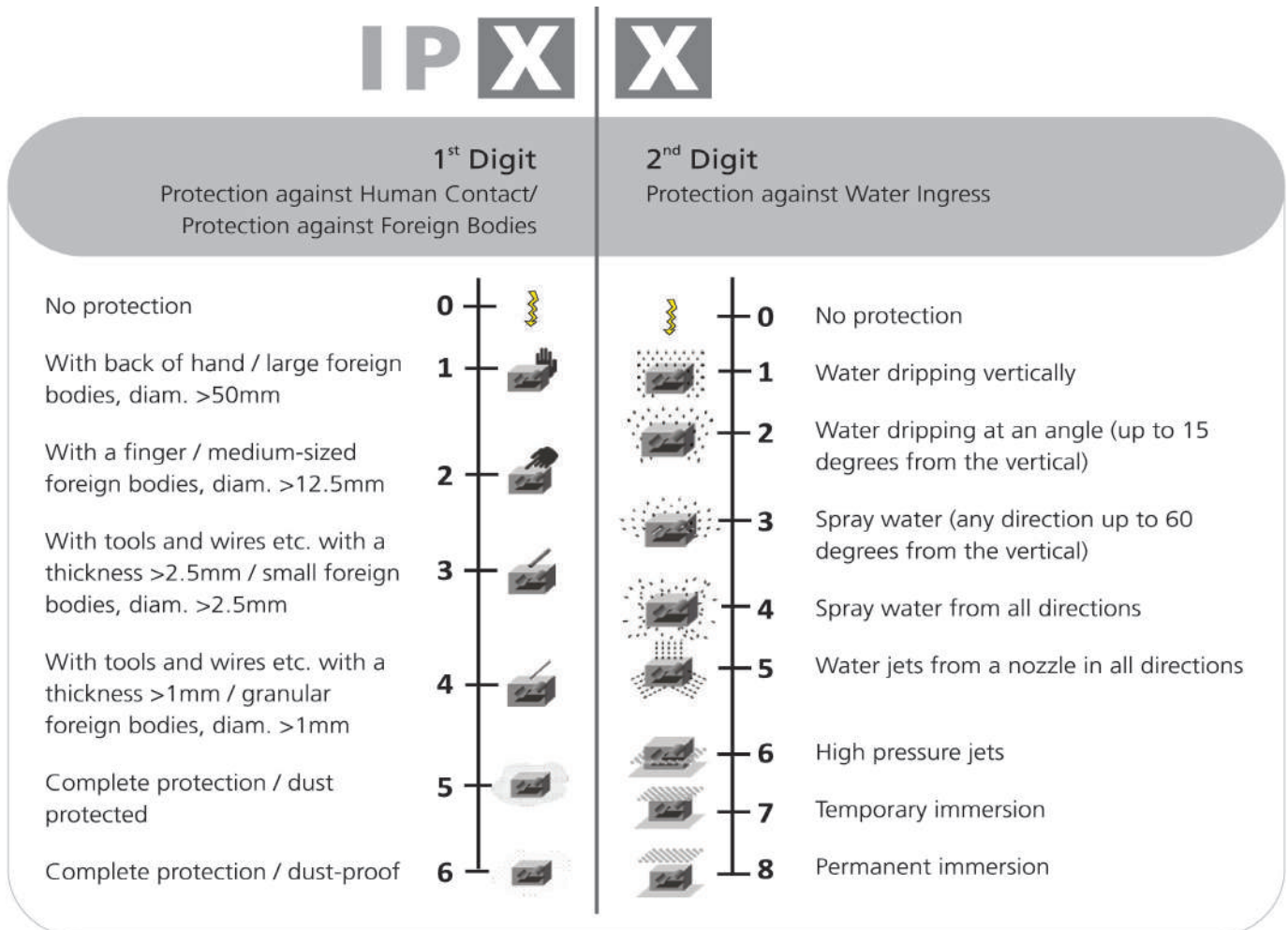



d. Suitability for Isolation

Certain devices are intended to provide isolation of the load from the source. Such devices can be termed 'suitable' for isolation provided they meet guidelines as indicated by IEC standard. Equipment suitable for isolation will have, in open position, an isolation distance in accordance with the requirements necessary to satisfy the isolation function. Further, the indication of the position of the main contacts is to be provided by one or more of the following means:

- The position of the actuator (or knob)
- A separate mechanical indicator
- Visibility of the moving contacts

A device suitable for isolation will bear an isolation function symbol. The example below shows a circuit-breaker suitable for isolation.

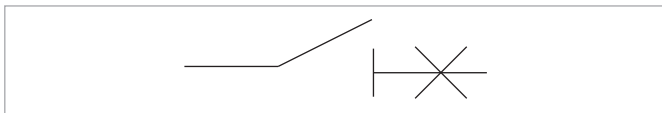

e. Energy Limiting Class (Reference EN 60898)

Circuit breakers are classified into different 'energy limiting classes' based on the amount of let-through energy (I^2t) they pass on to the downstream zone. The permissible let-through energy values, as per rated short-circuit breaking capacity and the characteristic curves are stated in the relevant product standard, EN 60898.

Energy Limiting Class 3, as defined, has lower let-through energy values than the other two classes.

MCBs

Temperature De-rating

As per IS/IEC 60898, thermal calibration of an MCB is to be done at 30°C. If the manufacturer decides to do it at any other temperature, the data has to be furnished on the breaker.

When used at ambient temperatures exceeding the calibrated temperatures, MCBs tend to trip faster while carrying the rated current. This calls for de-rating the MCBs when used in ambiances, with temperatures higher than the design ambient temperature. At temperatures higher than 30°C, the MCB requires progressively less time to trip on the same level of overload.

MCB Temperature De-rating										
In [A]	[°C]	AMBEINT TEMPERATURE								
		-25	-10	0	10	20	30	40	50	60
0.5		0.675	0.63	0.595	0.565	0.53	0.5	0.46	0.425	0.39
1		1.35	1.26	1.19	1.13	1.06	1	0.92	0.85	0.78
2		2.7	2.52	2.38	2.26	2.12	2	1.84	1.7	1.56
3		4.05	3.78	3.57	3.39	3.18	3	2.76	2.55	2.34
4		5.4	5.04	4.76	4.52	4.24	4	3.68	3.4	3.12
6		8.1	7.56	7.14	6.78	6.36	6	5.52	5.1	4.68
10		13.5	12.6	11.9	11.3	10.6	10	9.2	8.5	7.8
16		21.6	20.16	19.04	18.08	16.96	16	14.72	13.6	12.48
20		27	25.2	23.8	22.6	21.2	20	18.4	17	15.6
25		33.75	31.5	29.75	28.25	26.5	25	23	21.25	19.5
32		43.2	40.32	38.08	36.16	33.92	32	29.44	27.2	24.96
40		54	50.4	47.6	45.2	42.4	40	36.8	34	31.2
50		67.5	63	59.5	56.5	53	50	46	42.5	39
63		85.05	79.38	74.97	71.19	66.78	63	57.96	53.55	49.14



Grouping factor

Most of the time, MCBs are mounted in a stack or a group. The heating effect of these MCBs, when fully loaded, leads to considerable watt loss, and raises the temperature in the enclosure. The grouping factor for AU MCBs (0.5A-63A) is stated below.

No of MCBs in a stack	Grouping Factor
1	1
2	0.95
3	0.9
4 and above	0.85

Therefore, with the grouping factors listed above, the current rating of an MCB can be appropriately chosen.

Effect of frequency change

Magnetic - value multiplied by K

Thermal - unchanged

Current rating of an MCB can be appropriately chosen for different operating frequencies.

Frequency(Hz)	15Hz-60Hz	100Hz	200Hz	400Hz
K	1	1.1	1.2	1.5

Different types of MCB curves

Based on the various magnetic settings, the MCBs can be categorized as shown below.

Type	Magnetic setting	Application
B	3-5 In	Generator-sensitive loads very long circuit runs Example: Incandescent lights, heater, geyser
C	5-10 In	General, light and power Example: Flourescent lights, small motors, fans, refrigerators, window / split ACs
D	10-20 In	Transformers sodium lighting highly inductive loads Example: Water lifting pumps, UPS

AU-10 (MCBs) IT Characteristics

B Curve

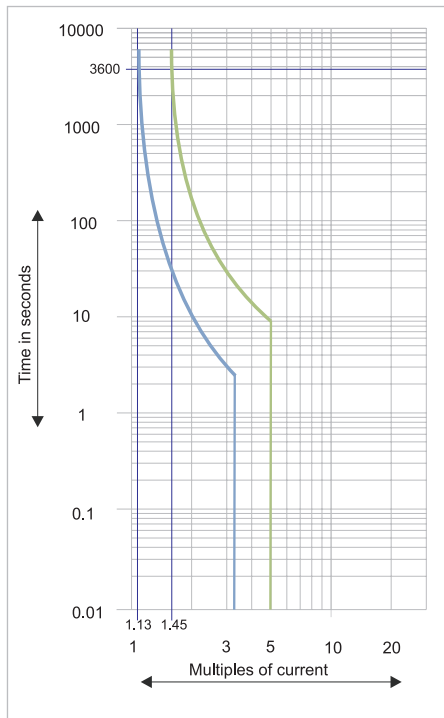

C Curve

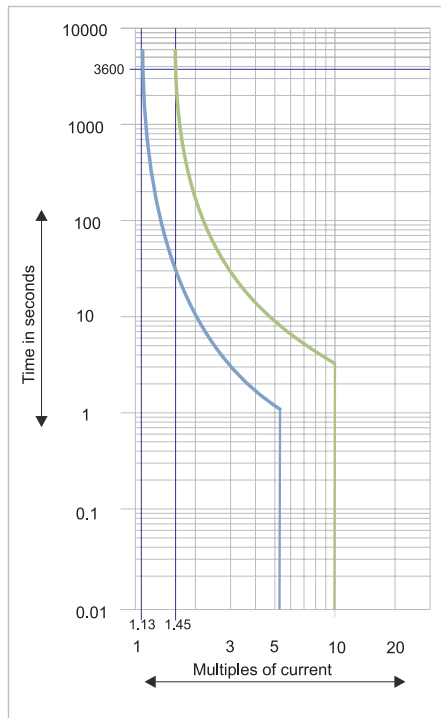

D Curve

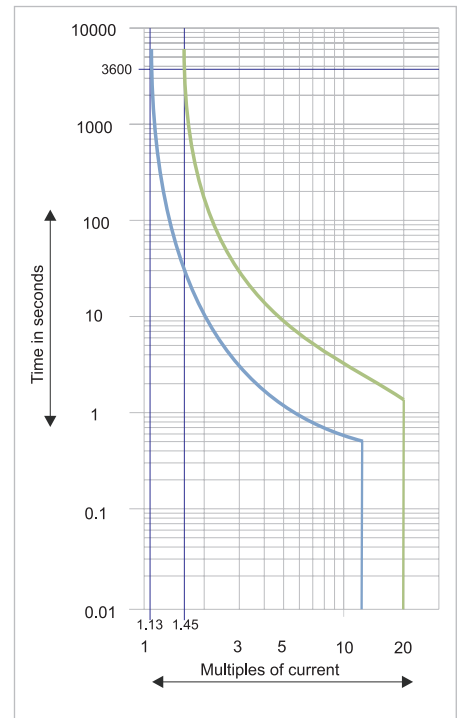



Current-limiting

Current limitation is the technique used in miniature circuit breakers to limit the short circuit current to reach its prospective value.

B Curve (6A-63A)

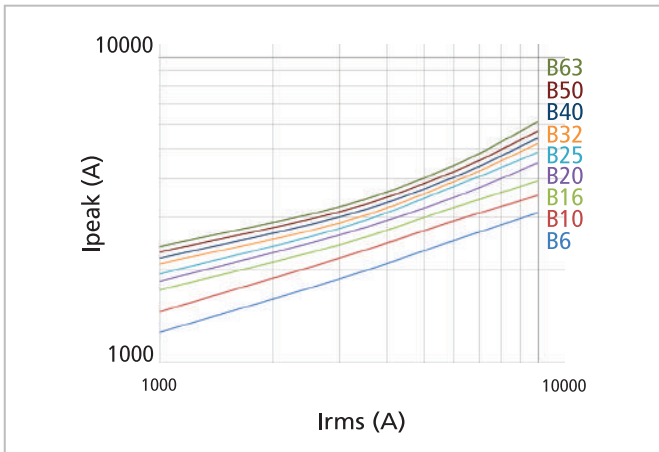

C Curve (6A-63A)

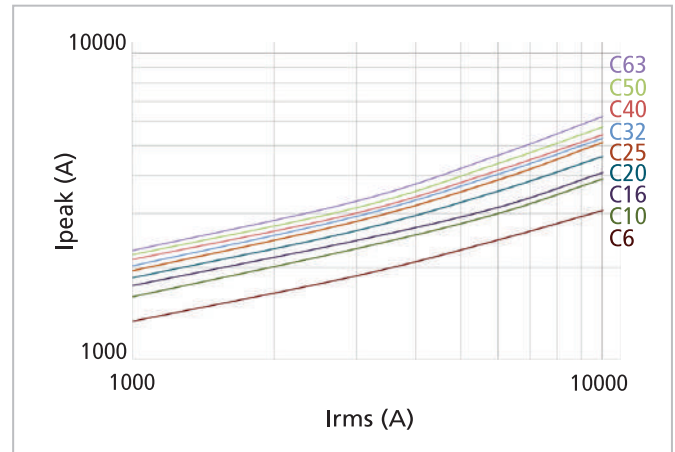

D Curve (6A-63A)

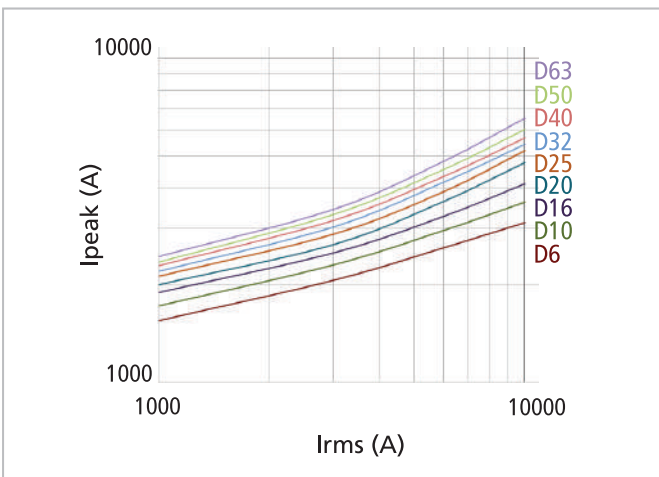

C Curve (0.5A-5A)

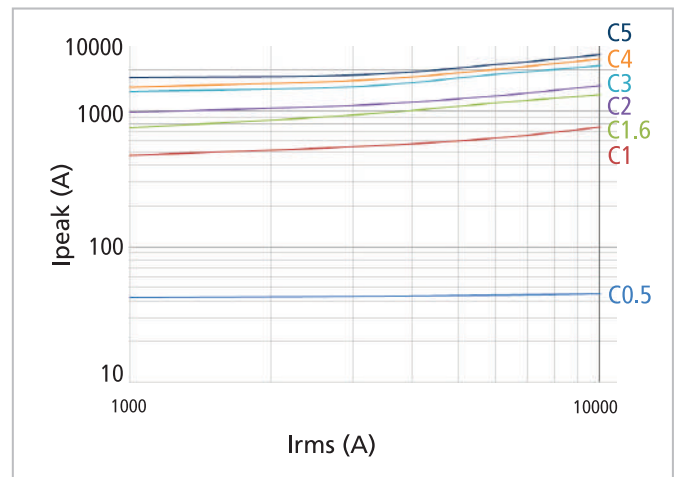

D Curve (0.5A-5A)

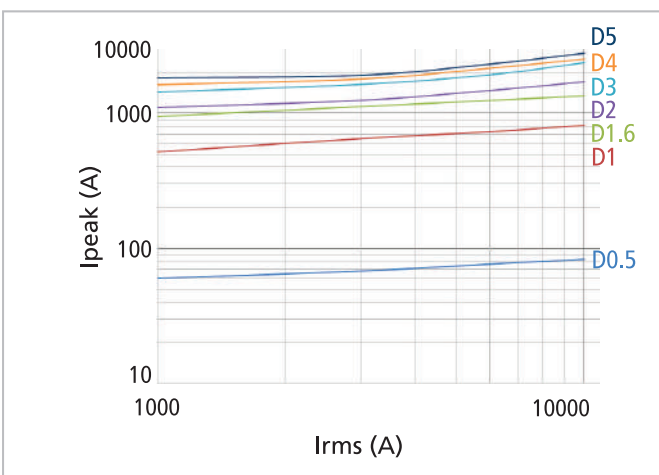



MCBs - Let Thru Energy - I^2t

Let Thru energy is the amount of fault energy which passes through a circuit breaker to the downstream network, measured from the instant a fault occurs in a system to the instant the miniature circuit breaker clears the fault.

B Curve (6A-63A)

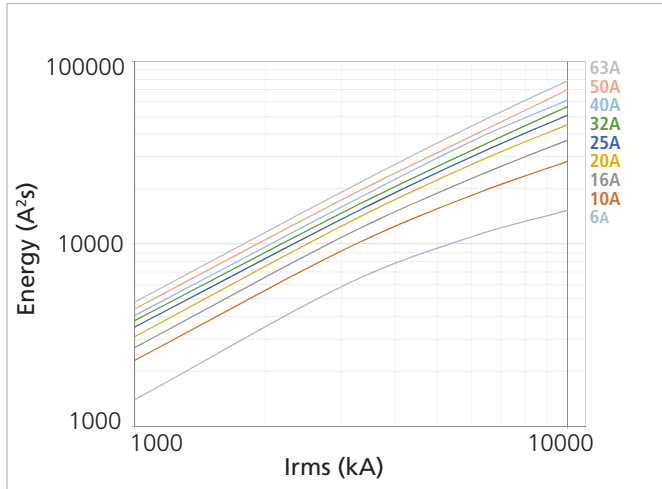

C Curve (6A-63A)

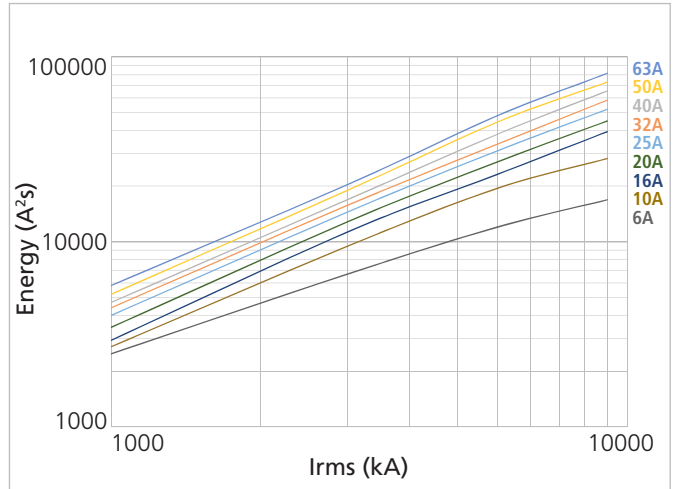

D Curve (6A-63A)

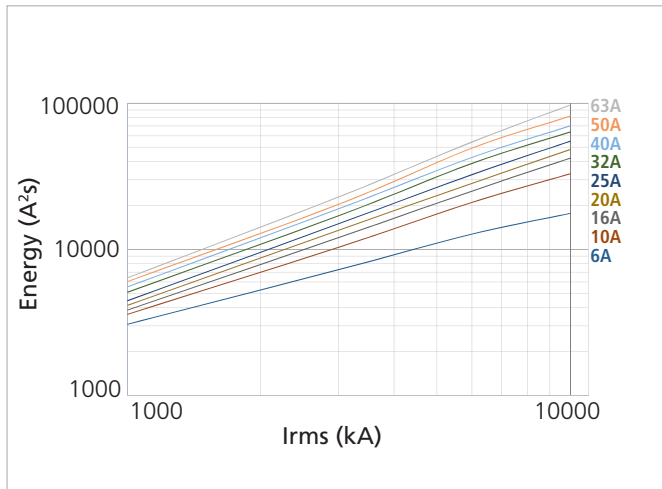

C Curve (0.5A-5A)

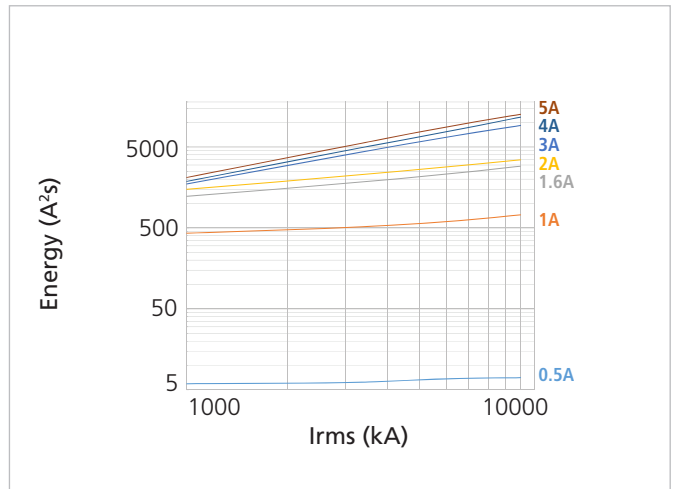

D Curve (0.5A-5A)

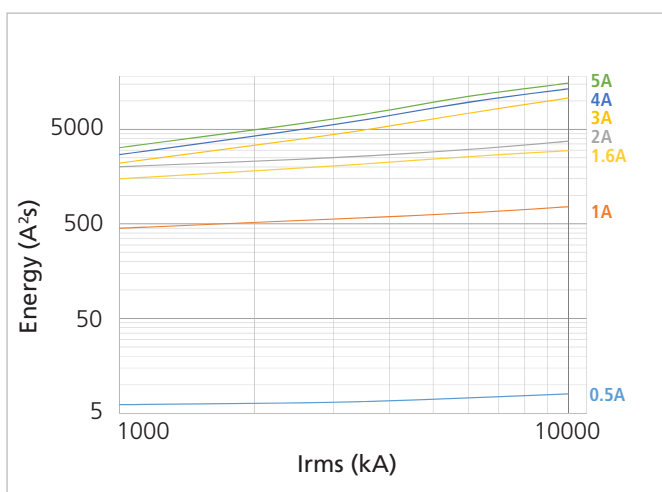

MCBs - Power Loss Per Pole (W)

Current Ratings (A)	As Per IS/ IEC 60898	For AU Range of MCBs	% lower
0.5	3	1.9	38%
1	3	2	33%
1.6	3	2.1	30%
2	3	2.1	30%
3	3	2.1	30%
4	3	2.1	30%
5	3	2.1	30%
6	3	1.1	63%
10	3	1.2	60%
16	3.5	1.8	50%
20	4.5	1.9	58%
25	4.5	2.1	54%
32	6	2.4	60%
40	7.5	3.1	59%
50	9	4.1	54%
63	13	4.3	67%
80	15	3.9	74%
100	15	6.2	59%
125	20	9.2	54%



RCBOs - Power loss (AU-O)

Current (A) In	Watt Loss (W)
6	1.1
10	1.2
16	1.8
20	1.9
25	2.1
32	2.4
40	3.1

RCBOs - Power loss (AU-F)

Current (A) In	Watt Loss (W)
16	2.6
20	2.7
25	3.1
32	3.6
40	4.8
63	8.1

RCBOs - Temperature De-rating (AU-O)



RCBO Temperature De-rating										
In [A]	[°C]	AMBIENT TEMPERATURE								
		-25	-10	0	10	20	30	40	50	60
6		8.1	7.56	7.14	6.78	6.36	6	5.52	5.1	4.68
10		13.5	12.6	11.9	11.3	10.6	10	9.2	8.5	7.8
16		21.6	20.16	19.04	18.08	16.96	16	14.72	13.6	12.48
20		27	25.2	23.8	22.6	21.2	20	18.4	17	15.6
25		33.75	31.5	29.75	28.25	26.5	25	23	21.25	19.5
32		43.2	40.32	38.08	36.16	33.92	32	29.44	27.2	24.96
40		54	50.4	47.6	45.2	42.4	40	36.8	34	31.2

RCCBs - Watt loss (AU-R)

Current (A)	Watt Loss (W)-2P	Watt Loss (W)-4P
16	0.3	-
25	0.7	0.8
40	2.3	2.3
63	4	4.7
80	4	4.8
100	6	6.7

Short circuit withstand offered by RCCB

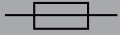
(Upstream SCPD should be selected to Maintain I_t and I_p as specified in product standard)

	 gI - 10kA With backup fuse					 230/400 V - 10 kA With backup MCB		
	25 A	40 A	63 A	80 A	100 A	25 A	40 A	63 A
16 A	10 kA	10 kA	10 kA	10 kA	10 kA	10 kA	10 kA	10 kA
25 A	10 kA	10 kA	10 kA	10 kA	10 kA	10 kA	10 kA	10 kA
40 A		10 kA	10 kA	10 kA	10 kA		10 kA	10 kA
63 A			10 kA	10 kA	10 kA			10 kA
80 A				10 kA	10 kA			
100 A					10 kA			

Electrical Standard Products (ESP) Offices:

HEAD OFFICE

L&T Electrical & Automation
L&T Business Park,
Tower 'B' / 3rd Floor
Saki Vihar Road, Powai
Mumbai 400 072
Tel: 022-67053229
Fax: 022-67051112
e-mail: cic@LNTEBG.com

BRANCH OFFICES

L&T Electrical & Automation
501, Sakar Complex I
Opp. Gandhigram Rly. Station
Ashram Road
Ahmedabad 380 009
Tel: 079-66304006-11
Fax: 079-66304025
e-mail: esp-ahm@LNTEBG.com

L&T Electrical & Automation
M/s Larsen & Toubro Ltd
No 38, Cubbon Road
Bengaluru 560 001
Tel: 080-46136103 / 100
e-mail: esp-blr@LNTEBG.com

L&T Electrical & Automation
131/1, Zone II, Maharana Pratap Nagar
Bhopal 462 011
Tel: 0755-3080511 / 05 / 08 / 13 / 17 / 19
Fax: 0755-3080502
e-mail: esp-bho@LNTEBG.com

L&T Electrical & Automation
Plot No. 559, Annapurna Complex
Lewis Road
Bhubaneswar 751 014
Tel: 0674-6451342 / 2436690 / 2436696
Fax: 0674-2537309
e-mail: esp-bsr@LNTEBG.com

L&T Electrical & Automation
Aspire Towers, 4th Floor
Plot No. 55, Phase-I
Industrial & Business Park
Chandigarh 160 002
Tel: 0172-4646840 / 41 / 42 / 46 / 53
Fax: 0172-4646802
Email: esp-chd@LNTEBG.com

L&T Electrical & Automation
L&T Construction Campus
TC-1 Building, II Floor
Mount-Poonamallee Road
Manapakkam
Chennai 600 089
Tel: 044-2270 6800
Fax: 044-2270 6940
e-mail: esp-maa1@LNTEBG.com

L&T Electrical & Automation
67, Appuswamy Road, Post Bag 7156
Opp. Nirmala College
Coimbatore 641 045
Tel: 0422-4588120 / 1 / 5
Fax: 0422-2588148
e-mail: esp-cbe@LNTEBG.com

L&T Electrical & Automation
1&2, Vijay Park, Main Chakrata road
Opp: Anandam, Ballapur Chowk
Dehradun 248001
Tel: 9582252411

L&T Electrical & Automation
Khairasol, Degaul Avenue
Durgapur 713 212
Tel: 0343-2540448 / 2540449 / 2540443
Fax: 0343-2540442
e-mail: esp-dgp@LNTEBG.com

L&T Electrical & Automation
5, Milanpur Road, Bamuni Maidan
Guwahati 781 021
Tel: +91 8876554417
e-mail: esp-ghy@LNTEBG.com

L&T Electrical & Automation
II Floor, Vasantha Chambers
5-10-173, Fateh Maidan Road
Hyderabad 500 004
Tel: 040-67015052
Fax: 040-23296468
e-mail: esp-hyd@LNTEBG.com

L&T Electrical & Automation
Monarch Building, 1st Floor
D-236 & 237, Amrapali Marg
VaiShali Nagar
Jaipur 302 021
Tel: 0141-4385914 to 18
Fax: 0141-4385925
e-mail: esp-jai@LNTEBG.com

L&T Electrical & Automation
Akashdeep Plaza, 2nd Floor
P. O. Golmuri
Jamshedpur 831 003
Jharkhand
Tel: 0657-2312205 / 38
Fax: 0657-2341250
e-mail: esp-jam@LNTEBG.com

L&T Electrical & Automation
Skybright Bldg; M. G. Road
Ravipuram Junction, Ernakulam
Kochi 682 016
Tel: 0484-4409420 / 4 / 5 / 7
Fax: 0484-4409426
e-mail: esp-cok@LNTEBG.com

L&T Electrical & Automation
3-B, Shakespeare Sarani
Kolkata 700 071
Tel: 033-42005982
Fax: 033-22821025 / 7587
e-mail: esp-ccu@LNTEBG.com

L&T Electrical & Automation
No. 10, Fortuna Tower, 2nd Floor
Rana Pratap Marg, Near NBRI
Lucknow 226001
e-mail: esp-lko@LNTEBG.com

L&T Electrical & Automation
No: 73, Karpaga Nagar, 8th Street
K. Pudur
Madurai 625007
Tel: 0452-2567405 / 2561068 / 2561657
Fax: 0452-2567552
e-mail: esp-mdu@LNTEBG.com

L&T Electrical & Automation
L&T Business Park, Tower 'B' / 3rd Floor
Saki Vihar Road, Powai
Mumbai 400 072
Tel: 022-67052874 / 2737 / 1156
Fax: 022-67051112
e-mail: esp-bom@LNTEBG.com

L&T Electrical & Automation
Unnati Building, 2nd Floor
Automation Campus
A-600, TTC Industrial area
Shil-Mahape road, Mahape
Navi Mumbai 400710

L&T Electrical & Automation
12, Shivaji Nagar
North Ambajhari Road
Nagpur 440 010
Tel: 0712-2260012 / 6606421
Fax: 2260030 / 6606434
e-mail: esp-nag@LNTEBG.com

L&T Electrical & Automation
32, Shivaji Marg
P. O. Box 6223
New Delhi 110 015
Tel: 011-41419514 / 5 / 6
Fax: 011-41419600
e-mail: esp-del@LNTEBG.com

L&T Electrical & Automation
Grand Chandra, 2nd Floor
Fraser Road
Opposite Doordarshan Kendra
Patna 800001
Tel: 8102440613
e-mail: esp-patna@LNTEBG.com

L&T Electrical & Automation
L&T House
P. O. Box 119
191/1, Dhole Patil Road
Pune 411 001
Tel: 020-48544395 / 48544279
e-mail: esp-pnq@LNTEBG.com

L&T Electrical & Automation
Crystal Tower,
4th Floor, G. E. Road
Telibandha
Raipur 492 006
Tel: 0771-4283214
e-mail: esp-raipur@LNTEBG.com

L&T Electrical & Automation
3rd Floor
Vishwakarma Chambers
Majura Gate, Ring Road
Surat 395 002
Tel: 0261-2473726
Fax: 0261-2477078
e-mail: esp-sur@LNTEBG.com

L&T Electrical & Automation
Radhadaya Complex
Old Padra Road
Near Charotar Society
Vadodara 390 007
Tel: 0265-6613610 / 1 / 2
Fax: 0265-2336184
e-mail: esp-bar@LNTEBG.com

L&T Electrical & Automation
Door No. 49-38-14/3/2, 1st floor,
NGGO's Colony, Akkayyapalem,
Visakhapatnam 530 016
Tel: 0891-2791126 / 2711125
Fax: 0891-2791100
e-mail: esp-viz@LNTEBG.com

Product improvement is a continuous process. For the latest information and special application, please contact any of our offices listed here. Product photographs shown for representative purpose only.



L&T Electrical & Automation, Electrical Standard Products

L&T Business Park, TC-2, Tower B, 3rd Floor, Gate No. 5, Saki Vihar Road, Powai,
Mumbai - 400 072, INDIA www.Lntebg.com

Customer Interaction Center (CIC)

BSNL / MTNL (toll-free): 1800 233 5858 Reliance (toll-free): 1800 200 5858
Tel: 022 6774 5858 Email: cic@Lntebg.com Web: www.Lntebg.com